

2014 ***catalogue***

SECOND EDITION

belt tensioners
belt idlers





AUTOBAX







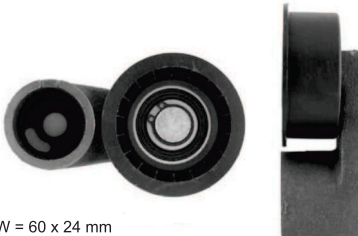
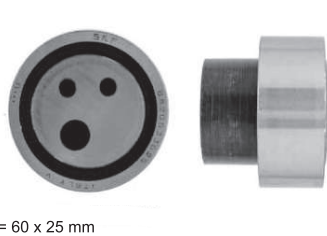
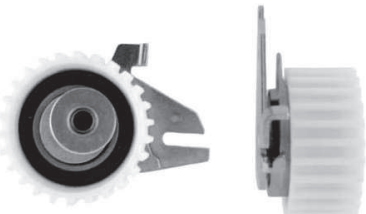
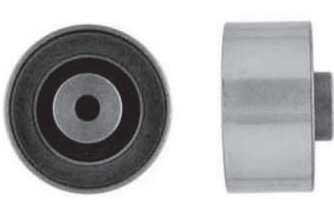
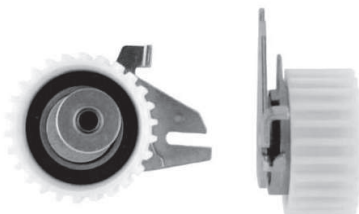
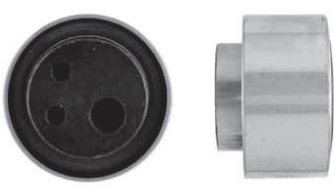
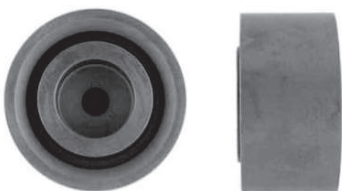
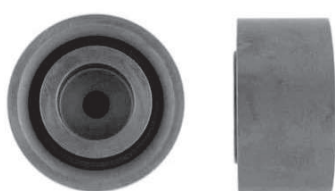

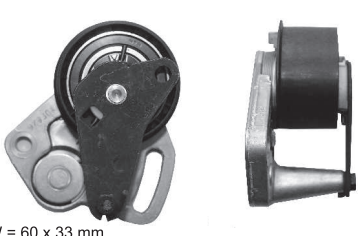
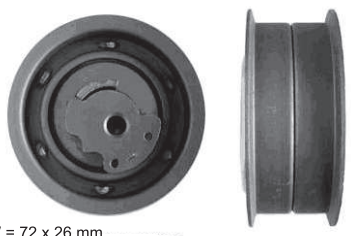
Division of
Humulani Marketing (Pty) Ltd
Reg. No. 2005/019581/07

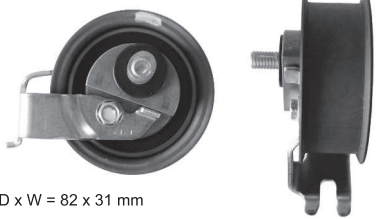

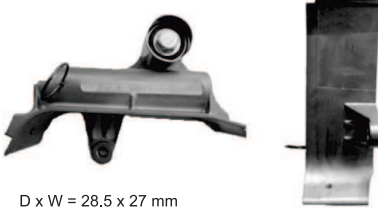
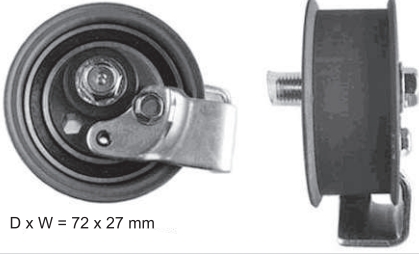

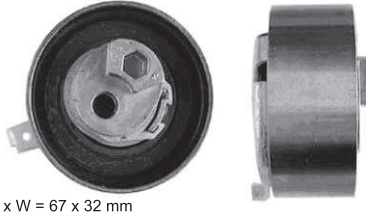
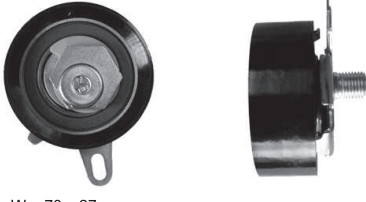
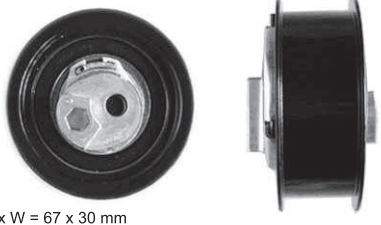

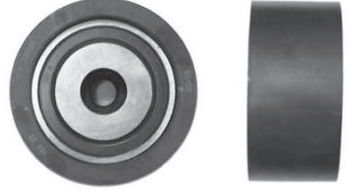
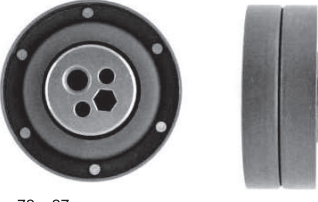
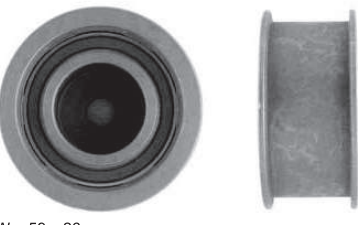



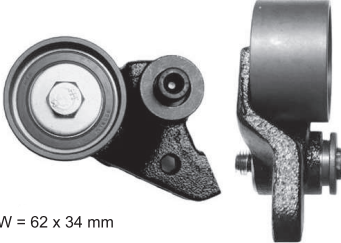

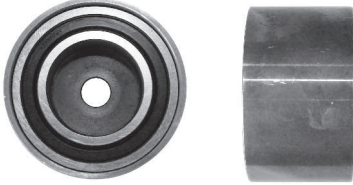
2014

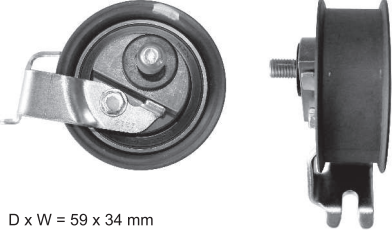
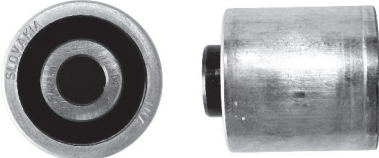
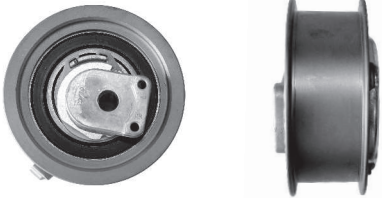
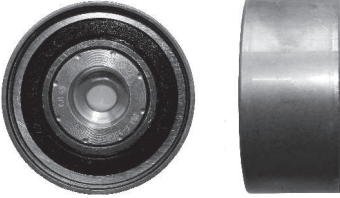
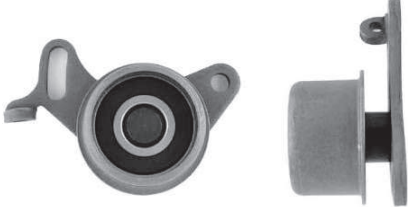
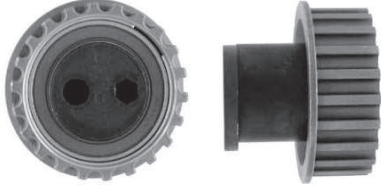





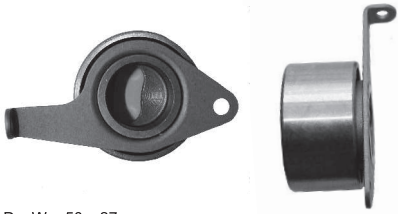

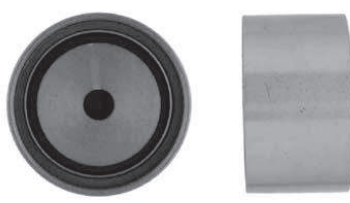
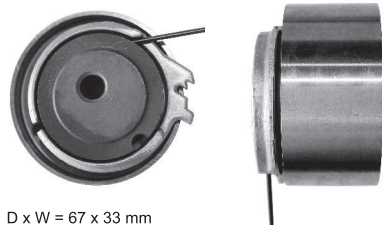
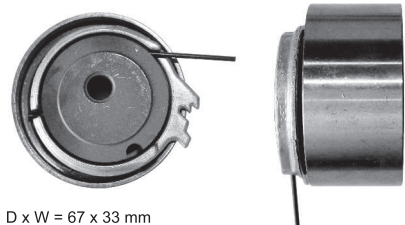
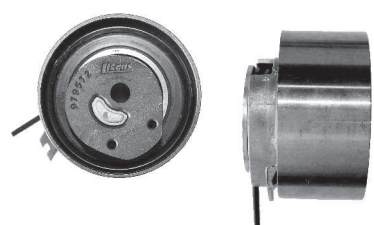
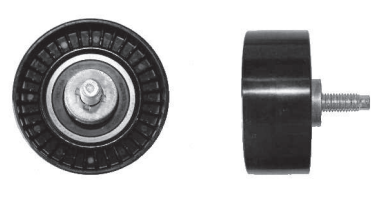
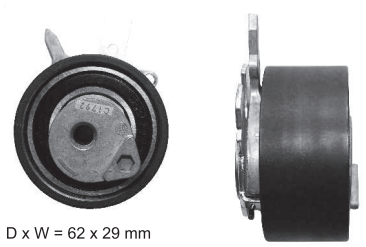
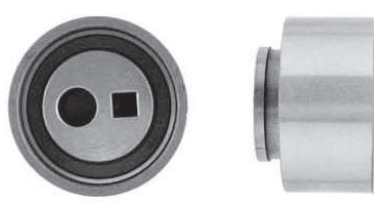
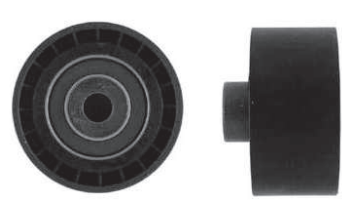
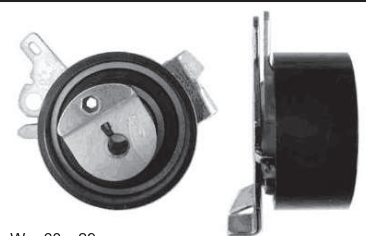

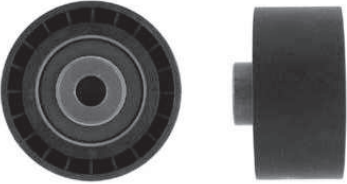
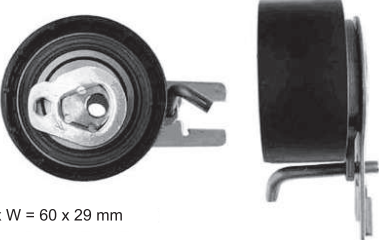
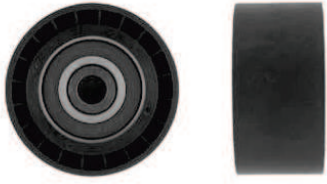
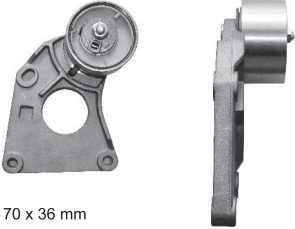

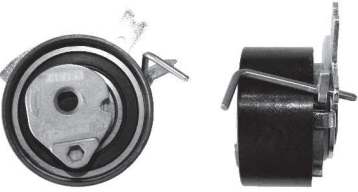
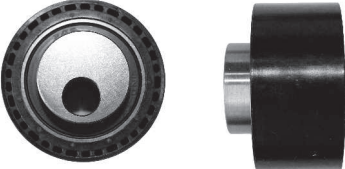
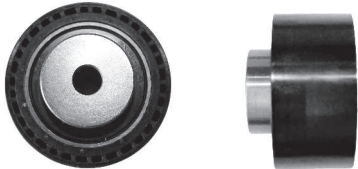
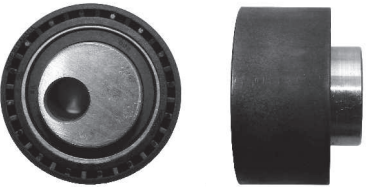
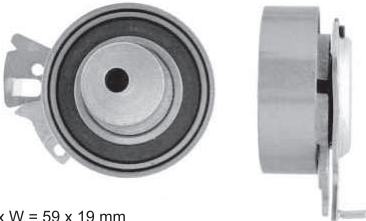
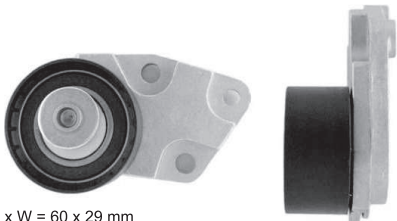
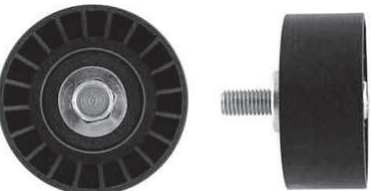





ALFA ROMEO	ALFA ROMEO	ALFA ROMEO/LANCIA
 <p>D x W = 60 x 23 mm</p>	 <p>D x W = 60 x 24 mm</p>	 <p>D x W = 60 x 25 mm</p>
BT ALF01 ALF098(2)/ALF100(2)	BT ALF02 ALF098(2)/ALF100(2)	BT ALF03 ALF142
ALFA ROMEO	ALFA ROMEO	ALFA ROMEO/LANCIA
 <p>D x W = 65 x 29 mm</p>	 <p>D x W = 57 x 29 mm</p>	 <p>D x W = 65 x 29 mm</p>
BT ALF04 ALF163/FIA166	BT ALF05 ALF163/ALF168/FIA166	BT ALF06 ALF168
ALFA ROMEO/LANCIA	ALFA ROMEO	ALFA ROMEO/LANCIA
 <p>D x W = 58 x 29 mm</p>	 <p>D x W = 68 x 34 mm</p>	 <p>D x W = 68 x 34 mm</p>
BT ALF07 ALF173	BT ALF08 ALF174	BT ALF09 ALF185
ALFA ROMEO	ALFA ROMEO	AUDI
 <p>D x W = 58 x 16 mm</p>	 <p>D x W = 60 x 33 mm</p>	 <p>D x W = 72 x 26 mm</p>
BT ALF10 ALF 130	BT ALF11 ALF 185	BT AUD01 AUDI 147

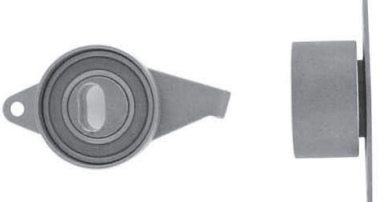
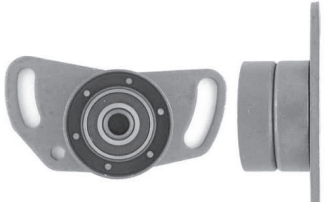





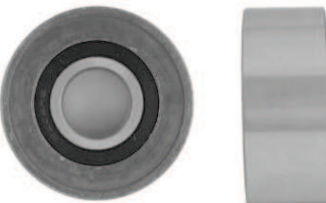
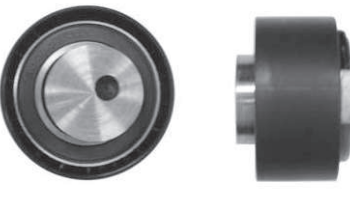

<p>AUDI/VOLKSWAGEN/SEAT</p>  <p>D x W = 82 x 31 mm</p> <p>BT AUD02 AUDI 150</p>	<p>AUDI/VOLKSWAGEN/SEAT</p>  <p>D x W = 82 x 31 mm</p> <p>BT AUD02A AUDI 150</p>	<p>AUDI/VOLKSWAGEN</p>  <p>D x W = 69 x 28 mm</p> <p>BT AUD03 AUDI 142</p>
<p>AUDI/VOLKSWAGEN/SEAT</p>  <p>D x W = 28.5 x 27 mm</p> <p>BT AUD04 AUD150-AUDI APPLICATIONS</p>	<p>AUDI</p>  <p>D x W = 72 x 27 mm</p> <p>BT AUD05 AUD153</p>	<p>AUDI</p>  <p>D x W = 29 x 29 mm</p> <p>BT AUD06 AUD153/160-25/VW141-25P&S/VW141-26</p>
<p>AUDI/VOLKSWAGEN</p>  <p>D x W = 67 x 32 mm</p> <p>BT AUD07 AUD083</p>	<p>AUDI</p>  <p>D x W = 73 x 27 mm</p> <p>BT AUD08 AUD087</p>	<p>AUDI/VOLKSWAGEN/SEAT</p>  <p>D x W = 67 x 30 mm</p> <p>BT AUD09 AUD145/AUD148/AUD150</p>
<p>AUDI/VOLKSWAGEN/SEAT</p>  <p>D x W = 29 x 27 mm</p> <p>BT AUD10 AUD145/AUD148/AUD150</p>	<p>AUDI</p>  <p>D x W = 72 x 34 mm</p> <p>BT AUD11 AUD207</p>	<p>AUDI</p>  <p>D x W = 70 x 34 mm</p> <p>BT AUD12 AUD207</p>
<p>AUDI</p>  <p>D x W = 72 x 27 mm</p> <p>BT AUD13 AUD239</p>	<p>AUDI</p>  <p>D x W = 59 x 26 mm</p> <p>BT AUD14 AUD239</p>	<p>AUDI/VOLKSWAGEN</p>  <p>D x W = 73 x 32 mm</p> <p>BT AUD15 AUD253</p>



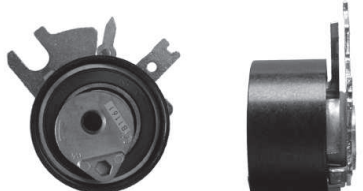
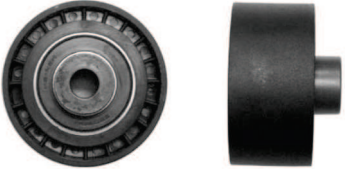

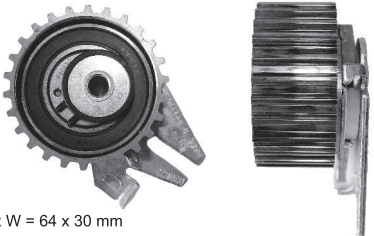
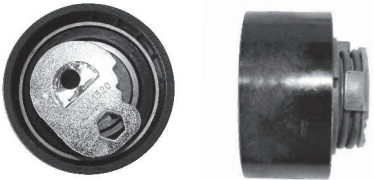
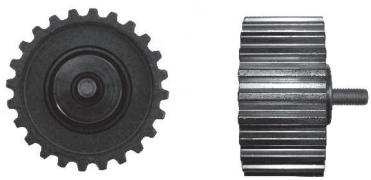
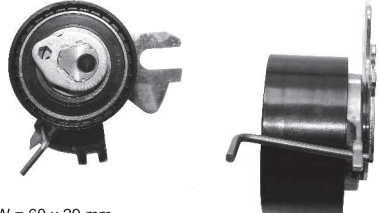

<p>AUDI/VOLKSWAGEN</p>	<p>AUDI</p>	<p>AUDI</p>
 <p>D x W = 60 x 31 mm</p>	 <p>D x W = 62 x 34 mm</p>	 <p>D x W = 29 x 34 mm</p>
<p>BT AUD16 AUD253</p>	<p>BT AUD17 AUD299</p>	<p>BT AUD18 AUD299</p>
<p>AUDI</p>	<p>AUDI</p>	<p>AUDI</p>
 <p>D x W = 65 x 33 mm</p>	 <p>D x W = 59 x 34 mm</p>	
<p>BT AUD19 AUDI 281</p>	<p>BT AUD20 AUDI 281</p>	<p>BT AUD21 AUDI 281</p>
<p>AUDI</p>	<p>AUDI</p>	<p>AUDI</p>
 <p>D x W = 59 x 34 mm</p>	 <p>D x W = 38 x 29 mm</p>	 <p>D x W = 67 x 25 mm</p>
<p>BT AUD22 AUDI 281</p>	<p>BT AUD23 AUD148</p>	<p>BT AUD24 AUD145/AUD148</p>
<p>AUDI</p>	<p>BMW</p>	<p>BMW</p>
 <p>D x W = 59 x 27 mm</p>	 <p>D x W = 50 x 29 mm</p>	 <p>D x W = 65 x 23 mm</p>
<p>BT AUD25 AUD145</p>	<p>BT BMW01 BMW127</p>	<p>BT BMW02 BMW110R-20,7</p>
<p>BMW</p>	<p>BMW</p>	<p>BMW</p>
 <p>D x W = 50 x 21 mm</p>	 <p>D x W = 32 x 22 mm</p>	 <p>D x W = 65 x 23 mm</p>
<p>BT BMW03 BMW110R-20,7</p>	<p>BT BMW04 BMW110R-20,7</p>	<p>BT BMW05 BMW110R-20,7-ALTERNATE TO BT BMW02</p>

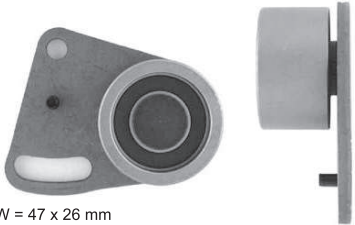
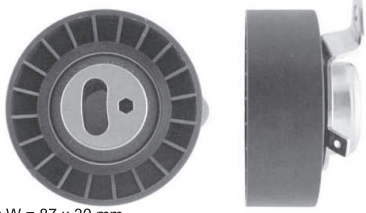
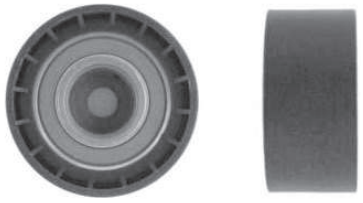

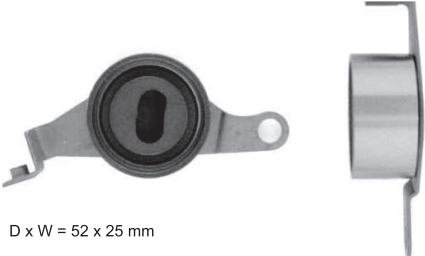
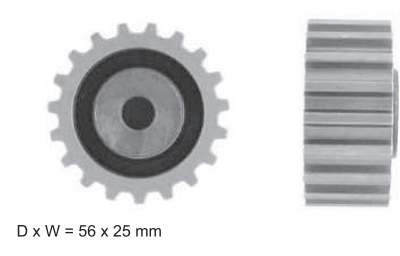
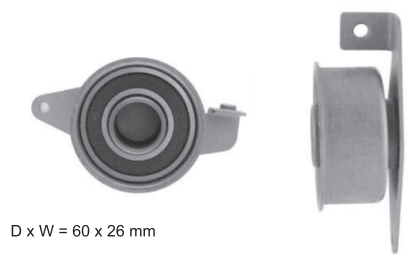
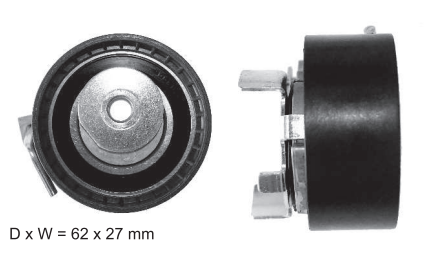
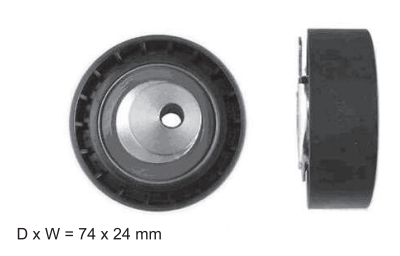
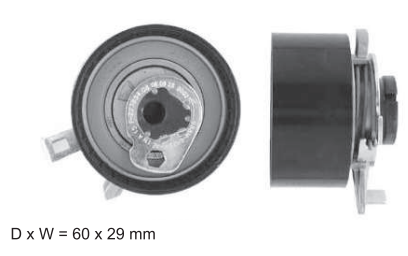
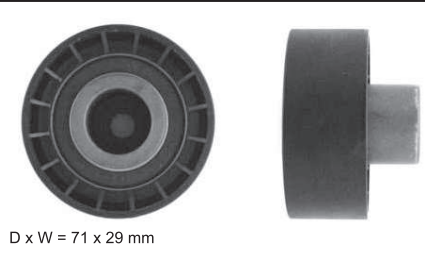
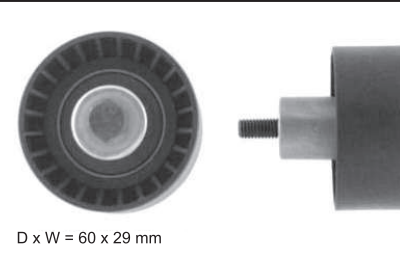

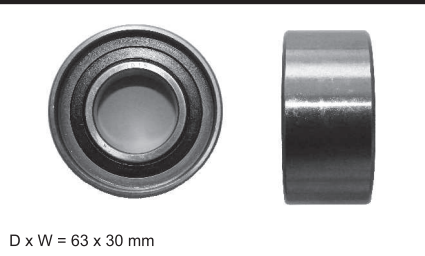



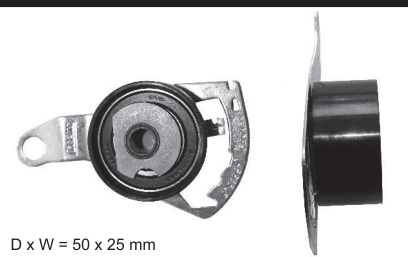

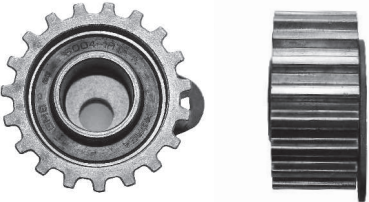
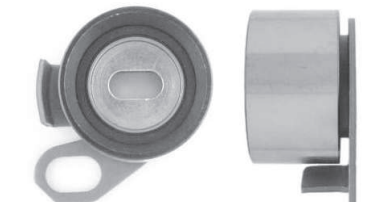
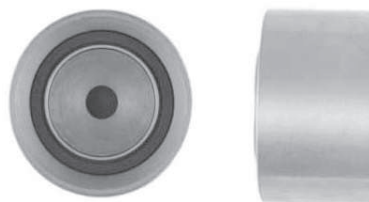
<p style="text-align: center;">CHERY</p>  <p>D x W = 50 x 27 mm</p> <p style="text-align: center;">BT CHE01 CHE107</p>	<p style="text-align: center;">CHERY</p> <p style="text-align: center;"><i>PHOTO NOT AVAILABLE</i></p> <p style="text-align: center;">BT CHE02 CHE173</p>	<p style="text-align: center;">CHERY</p> <p style="text-align: center;"><i>PHOTO NOT AVAILABLE</i></p> <p style="text-align: center;">BT CHE03 CHE173</p>
<p style="text-align: center;">CHERY</p> <p style="text-align: center;"><i>PHOTO NOT AVAILABLE</i></p> <p style="text-align: center;">BT CHE04 CHE173</p>	<p style="text-align: center;">CHRYSLER</p> <p style="text-align: center;">D x W = 67 x 33 mm</p>  <p style="text-align: center;">BT CHR01 CHR146</p>	<p style="text-align: center;">CHRYSLER</p>  <p style="text-align: center;">D x W = 58 x 35 mm</p> <p style="text-align: center;">BT CHR02 CHR146</p>
<p style="text-align: center;">CHRYSLER</p>  <p style="text-align: center;">D x W = 62 x 35 mm</p> <p style="text-align: center;">BT CHR03 CHR150</p>	<p style="text-align: center;">CHRYSLER</p>  <p style="text-align: center;">D x W = 67 x 33 mm</p> <p style="text-align: center;">BT CHR04 CHR112/150</p>	<p style="text-align: center;">CHRYSLER</p>  <p style="text-align: center;">D x W = 67 x 33 mm</p> <p style="text-align: center;">BT CHR05 CHR146</p>
<p style="text-align: center;">CHRYSLER</p>  <p style="text-align: center;">D x W = 67 x 33 mm</p> <p style="text-align: center;">BT CHR06 CHR220</p>	<p style="text-align: center;">CHRYSLER</p>  <p style="text-align: center;">D x W = 76 x 32 mm</p> <p style="text-align: center;">BT CHR07 CHR220</p>	<p style="text-align: center;">CHRYSLER</p>  <p style="text-align: center;">D x W = 62 x 29 mm</p> <p style="text-align: center;">BT CHR08 CHR171</p>
<p style="text-align: center;">CITROEN</p>  <p style="text-align: center;">D x W = 60 x 30 mm</p> <p style="text-align: center;">BT CIT01 CIT140/CIT141/146-25</p>	<p style="text-align: center;">CITROEN</p>  <p style="text-align: center;">D x W = 60 x 30 mm</p> <p style="text-align: center;">BT CIT02 CIT140/CIT141/146-25</p>	<p style="text-align: center;">CITROEN/PEUGEOT</p>  <p style="text-align: center;">D x W = 60 x 29 mm</p> <p style="text-align: center;">BT CIT03 PEU153</p>

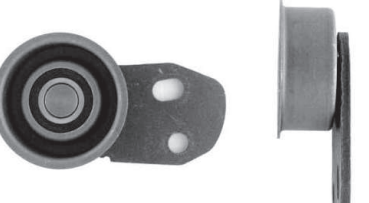
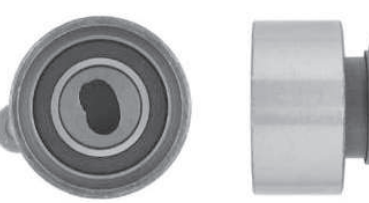

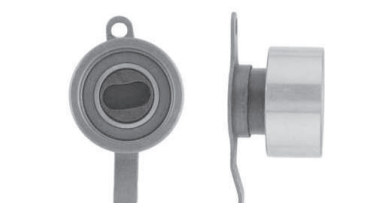

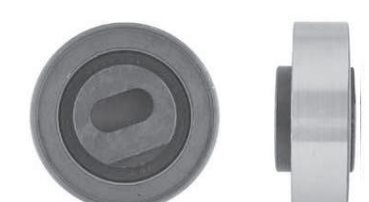

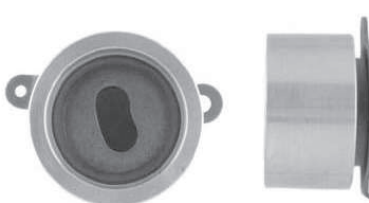

<p>CITROEN/PEUGEOT</p>  <p>D x W = 60 x 30 mm</p> <p>BT CIT04 PEU153</p>	<p>CITROEN/PEUGEOT</p>  <p>D x W = 60 x 29 mm</p> <p>BT CIT05 CIT137/CIT144</p>	<p>CITROEN/PEUGEOT</p>  <p>D x W = 60 x 30 mm</p> <p>BT CIT06 CIT137/CIT144</p>
<p>CITROEN</p>  <p>D x W = 70 x 36 mm</p> <p>BT CIT07 CIT259</p>	<p>CITROEN</p>  <p>D x W = 65 x 36 mm</p> <p>BT CIT08 CIT259</p>	<p>CITROEN</p>  <p>D x W = 65 x 36 mm</p> <p>BT CIT09 CIT259</p>
<p>CITROEN</p>  <p>D x W = 60 x 29 mm</p> <p>BT CIT10 CIT118-25</p>	<p>CITROEN</p>  <p>D x W = 62 x 30 mm</p> <p>BT CIT11 CIT146-25</p>	<p>CITROEN</p>  <p>D x W = 62 x 30 mm</p> <p>BT CIT12 CIT146-25</p>
<p>CITROEN</p>  <p>D x W = 60 x 30 mm</p> <p>BT CIT13 CIT 141 / CIT146-25</p>	<p>DAEWOO</p>  <p>D x W = 59 x 19 mm</p> <p>BT DAE01 OPE111-17-DAEWOO APPLICATION</p>	<p>DAEWOO/CHEV</p>  <p>D x W = 60 x 29 mm</p> <p>BT DAE02 DAE127</p>
<p>DAEWOO/CHEV</p>  <p>D x W = 65 x 29 mm</p> <p>BT DAE03 DAE127</p>	<p>DAEWOO/CHEV</p>  <p>D x W = 72 x 22 mm</p> <p>BT DAE04 DAE125</p>	<p>DAEWOO/CHEV</p>  <p>D x W = 42 x 28 mm</p> <p>BT DAE05 DAE107/DAE109</p>

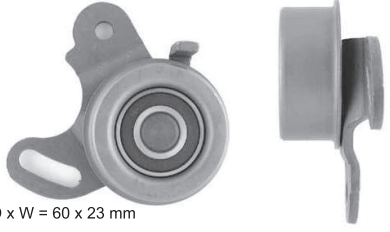

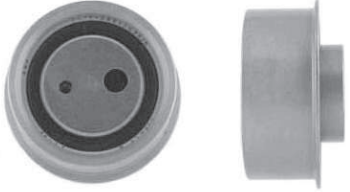
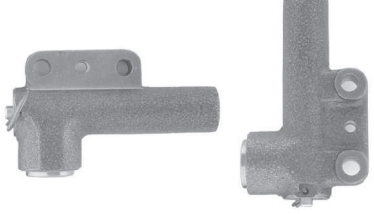
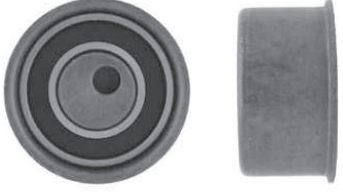

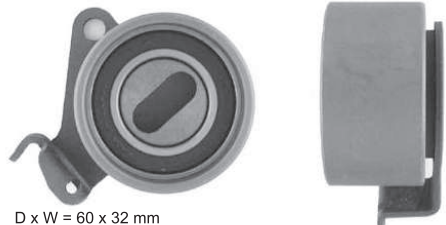
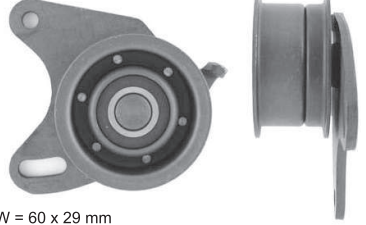
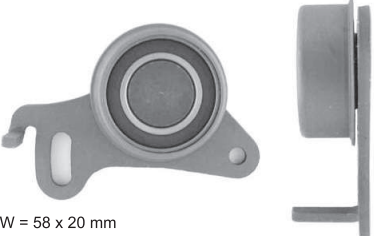
<p style="text-align: center;">DAIHATSU</p>  <p>D x W = 50 x 27 mm</p> <p style="text-align: center;">BT DAI01 DAI095/DAI093</p>	<p style="text-align: center;">DAIHATSU</p>  <p>D x W = 50 x 21 mm</p> <p style="text-align: center;">BT DAI02 DAI091/DAI103D</p>	<p style="text-align: center;">DAIHATSU</p>  <p>D x W = 51 x 22 mm</p> <p style="text-align: center;">BT DAI03 DAI103</p>
<p style="text-align: center;">DAIHATSU</p>  <p>D x W = 50 x 22 mm</p> <p style="text-align: center;">BT DAI04 DAI063</p>	<p style="text-align: center;">DAIHATSU</p>  <p>D x W = 50 x 27 mm</p> <p style="text-align: center;">BT DAI05 DAI111</p>	<p style="text-align: center;">DAIHATSU</p>  <p>D x W = 60 x 36 mm</p> <p style="text-align: center;">BT DAI06 DAI108</p>
<p style="text-align: center;">DAIHATSU</p>  <p>D x W = 54 x 36 mm</p> <p style="text-align: center;">BT DAI07 DAI108</p>	<p style="text-align: center;">FIAT</p>  <p>D x W = 58 x 24 mm</p> <p style="text-align: center;">BT FIA01 FIA104/108/125/129/138/OPE104S</p>	<p style="text-align: center;">FIAT</p>  <p>D x W = 60 x 29 mm</p> <p style="text-align: center;">BT FIA02 FIA158</p>
<p style="text-align: center;">FIAT</p>  <p>D x W = 65 x 30 mm</p> <p style="text-align: center;">BT FIA03 FIA158</p>	<p style="text-align: center;">FIAT/OPEL</p>  <p>D x W = 65 x 30 mm</p> <p style="text-align: center;">BT FIA04 FIA190/198-24/OPE190/199</p>	<p style="text-align: center;">FIAT/OPEL</p>  <p>D x W = 53 x 29 mm</p> <p style="text-align: center;">BT FIA05 FIA190/194/198/OPE190/199-OPEL</p>
<p style="text-align: center;">FIAT/LANCIA</p>  <p>D x W = 71 x 28 mm</p> <p style="text-align: center;">BT FIA06 FIA144/FIA146/FIA148</p>	<p style="text-align: center;">FIAT</p>  <p>D x W = 60 x 29 mm</p> <p style="text-align: center;">BT FIA07 FIA124</p>	<p style="text-align: center;">FIAT</p>  <p>D x W = 60 x 30 mm</p> <p style="text-align: center;">BT FIA08 FIA168</p>

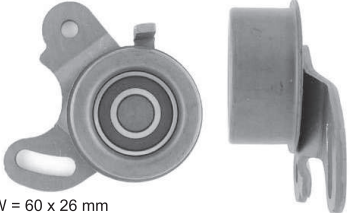

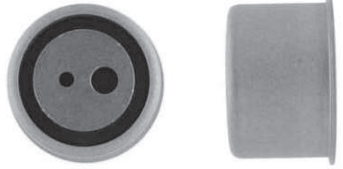

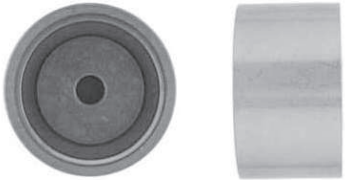
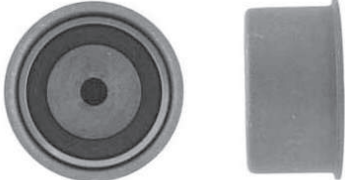
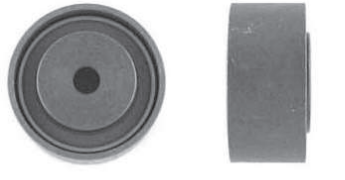
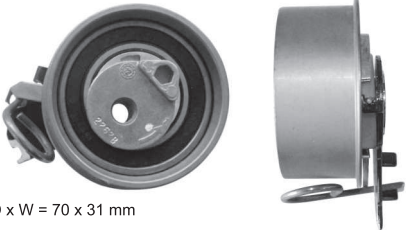
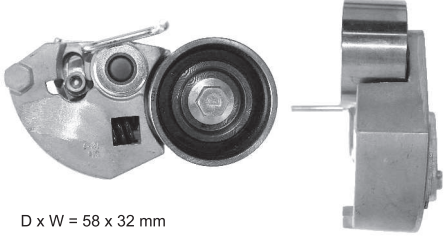
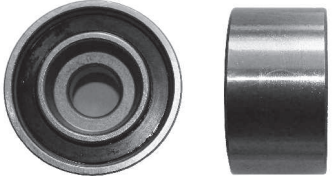
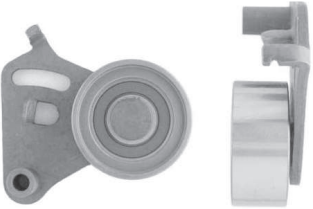
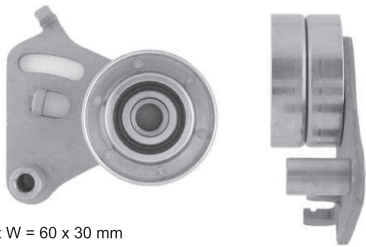
<p style="text-align: center;">FIAT</p>  <p>D x W = 61 x 30 mm</p> <p style="text-align: center;">BT FIA09 FIA168</p>	<p style="text-align: center;">FIAT</p>  <p>D x W = 65 x 29 mm</p> <p style="text-align: center;">BT FIA10 FIA134</p>	<p style="text-align: center;">FIAT</p>  <p>D x W = 60 x 29 mm</p> <p style="text-align: center;">BT FIA11 FIA116-25</p>
<p style="text-align: center;">FIAT</p>  <p>D x W = 60 x 30 mm</p> <p style="text-align: center;">BT FIA12 FIA116-25/REN116-25/CIT118-25</p>	<p style="text-align: center;">FIAT</p>  <p>D x W = 55 x 26 mm</p> <p style="text-align: center;">BT FIA13 FIA129-22</p>	<p style="text-align: center;">FIAT</p>  <p>D x W = 64 x 30 mm</p> <p style="text-align: center;">BT FIA14 FIA 194-24</p>
<p style="text-align: center;">FIAT</p>  <p>D x W = 69 x 34 mm</p> <p style="text-align: center;">BT FIA15 OPE178-30</p>	<p style="text-align: center;">FIAT</p>  <p>D x W = 71 x 34 mm</p> <p style="text-align: center;">BT FIA16 OPE178-30</p>	<p style="text-align: center;">FIAT</p>  <p>D x W = 60 x 29 mm</p> <p style="text-align: center;">BT FIA17 PEU116-25</p>
<p style="text-align: center;">FIAT</p>  <p>D x W = 54 x 29 mm</p> <p style="text-align: center;">BT FIA18 FIA166/FIA190/FIA193/FIA198-24</p>	<p style="text-align: center;">FORD</p>  <p>D x W = 47 x 32 mm</p> <p style="text-align: center;">BT FOR01 FOR092</p>	<p style="text-align: center;">FORD/MAZDA</p>  <p>D x W = 57 x 30 mm</p> <p style="text-align: center;">BT FOR02 FOR097</p>
<p style="text-align: center;">FORD</p>  <p>D x W = 47 x 26 mm</p> <p style="text-align: center;">BT FOR03 FOR122S/FOR122R</p>	<p style="text-align: center;">FORD</p>  <p>D x W = 87 x 30 mm</p> <p style="text-align: center;">BT FOR04 FOR131</p>	<p style="text-align: center;">FORD</p>  <p>D x W = 60 x 29 mm</p> <p style="text-align: center;">BT FOR05 FOR131</p>



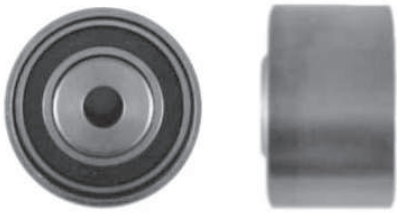
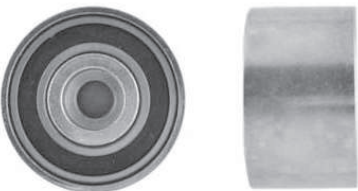
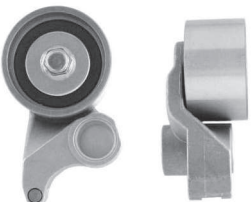
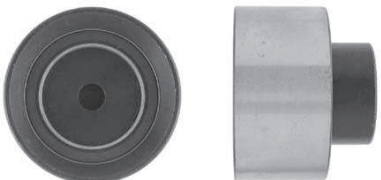

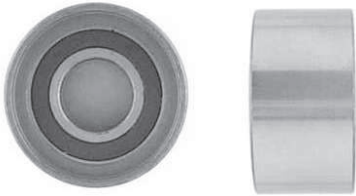
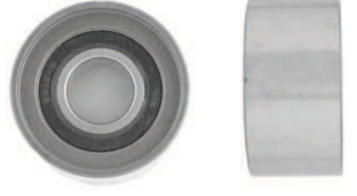
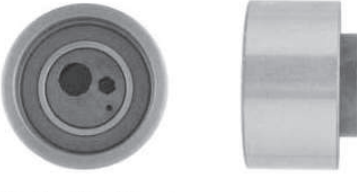
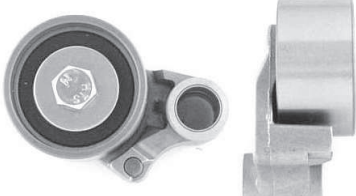
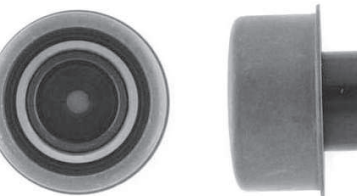
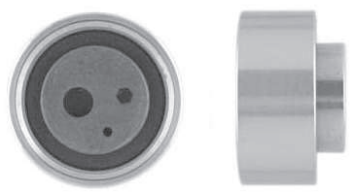
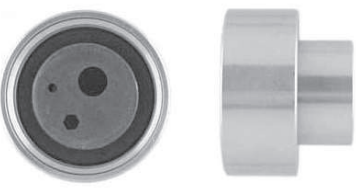
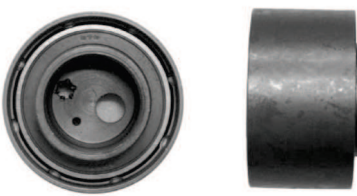
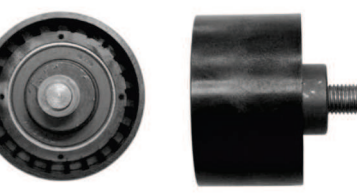

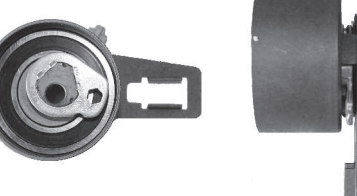

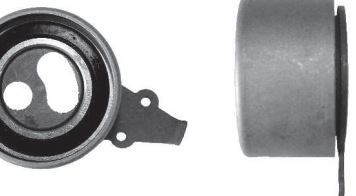
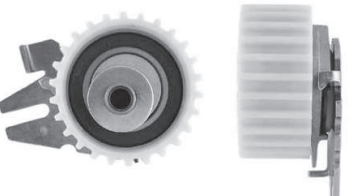
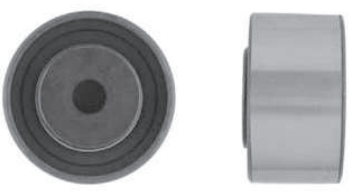



<p style="text-align: center;">FORD</p>  <p>D x W = 52 x 25 mm</p> <p style="text-align: center;">BT FOR06 FOR116</p>	<p style="text-align: center;">FORD</p>  <p>D x W = 56 x 25 mm</p> <p style="text-align: center;">BT FOR07 FOR116</p>	<p style="text-align: center;">FORD</p>  <p>D x W = 60 x 26 mm</p> <p style="text-align: center;">BT FOR08 FOR085</p>
<p style="text-align: center;">FORD</p>  <p>D x W = 62 x 27 mm</p> <p style="text-align: center;">BT FOR09 FOR117</p>	<p style="text-align: center;">FORD</p>  <p>D x W = 74 x 24 mm</p> <p style="text-align: center;">BT FOR10 FOR091</p>	<p style="text-align: center;">FORD</p>  <p>D x W = 60 x 29 mm</p> <p style="text-align: center;">BT FOR11 FOR129</p>
<p style="text-align: center;">FORD</p>  <p>D x W = 71 x 29 mm</p> <p style="text-align: center;">BT FOR12 FOR129-1998-1999</p>	<p style="text-align: center;">FORD</p>  <p>D x W = 60 x 29 mm</p> <p style="text-align: center;">BT FOR13 FOR129-2000 ON</p>	<p style="text-align: center;">FORD</p>  <p>D x W = 62 x 26 mm</p> <p style="text-align: center;">BT FOR14 FOR117</p>
<p style="text-align: center;">FORD</p>  <p>D x W = 63 x 30 mm</p> <p style="text-align: center;">BT FOR15 FOR123</p>	<p style="text-align: center;">FORD</p>  <p>D x W = 47 x 29 mm</p> <p style="text-align: center;">BT FOR16 FOR131</p>	<p style="text-align: center;">FORD</p>  <p>D x W = 47 x 29 mm</p> <p style="text-align: center;">BT FOR17 FOR129</p>
<p style="text-align: center;">FORD</p>  <p>D x W = 60 x 32 mm</p> <p style="text-align: center;">BT FOR18 FOR130</p>	<p style="text-align: center;">FORD</p>  <p>D x W = 60 x 32 mm</p> <p style="text-align: center;">BT FOR19 FOR13-25/FOR130-28</p>	<p style="text-align: center;">FORD</p>  <p>D x W = 50 x 25 mm</p> <p style="text-align: center;">BT FOR20 FOR116</p>



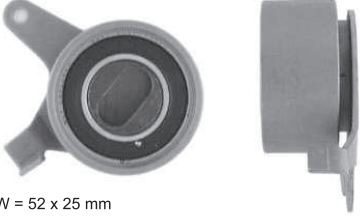

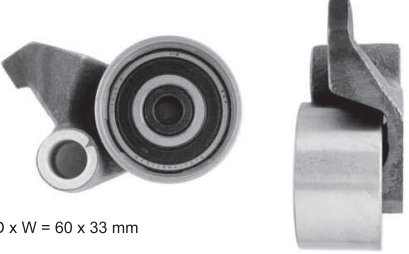
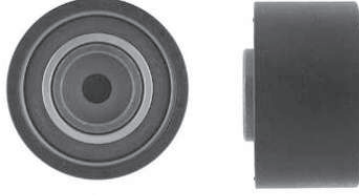
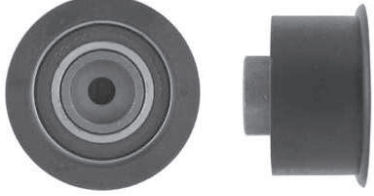

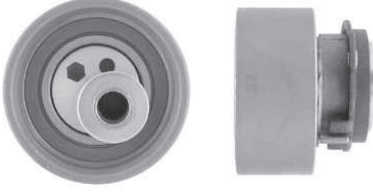

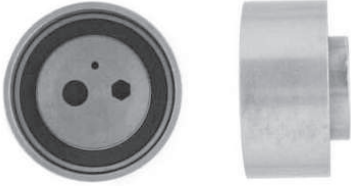
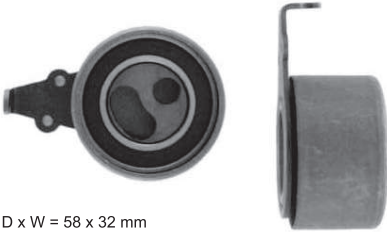

FORD	GWM	GWM
 <p>D x W = 56 x 25 mm</p>	 <p>D x W = 67 x 38 mm</p>	 <p>D x W = 67 x 38 mm</p>
<p>BT FOR21 FOR116</p>	<p>BT GWM01 GWM119</p>	<p>BT GWM02 GWM119</p>
HONDA	HONDA	HONDA
 <p>D x W = 52 x 27 mm</p>	 <p>D x W = 60 x 24 mm</p>	 <p>D x W = 55 x 28 mm</p>
<p>BT HON01 HON084</p>	<p>BT HON02 HON095</p>	<p>BT HON03 HON101</p>
HONDA	HONDA	HONDA
 <p>D x W = 55 x 28 mm</p>	 <p>D x W = 57 x 26 mm</p>	 <p>D x W = 53 x 26 mm</p>
<p>BT HON04 HON108</p>	<p>BT HON05 HON106/HON107/HON124-24</p>	<p>BT HON06 HON103/HON104</p>
HONDA	HONDA	HONDA
 <p>D x W = 60 x 28 mm</p>	 <p>D x W = 62 x 27 mm</p>	 <p>D x W = 70 x 19 mm</p>
<p>BT HON07 HON129</p>	<p>BT HON08 HON112/HON113</p>	<p>BT HON09 HON070</p>
HONDA	HONDA	HONDA
 <p>D x W = 55 x 28 mm</p>	 <p>D x W = 55 x 30 mm</p>	 <p>D x W = 55 x 28 mm</p>
<p>BT HON10 HON124-24-SOME ENGINES</p>	<p>BT HON11 HON124-24/HON125-26</p>	<p>BT HON12 HON155</p>

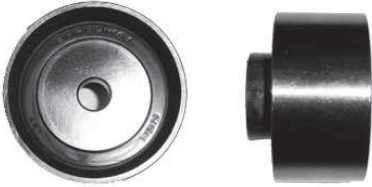
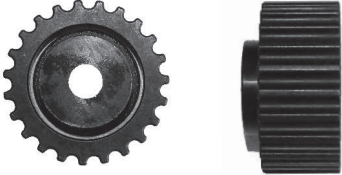
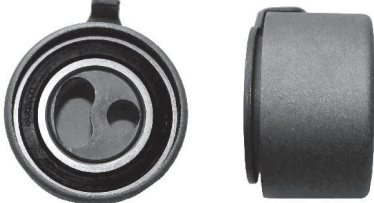
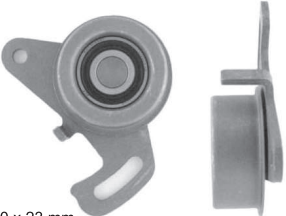

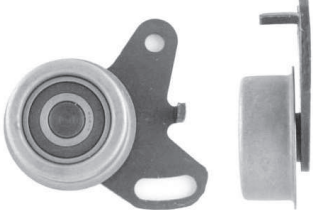

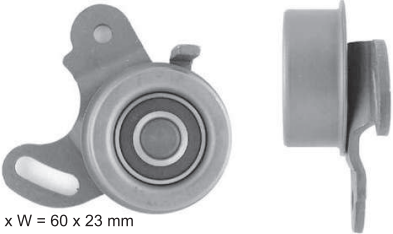
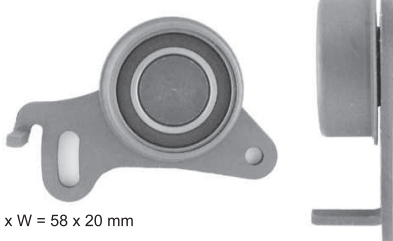

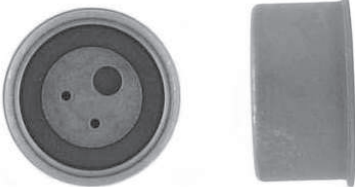

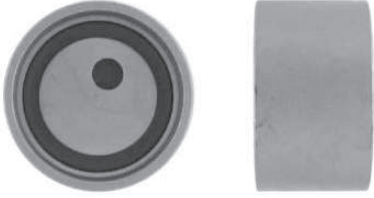
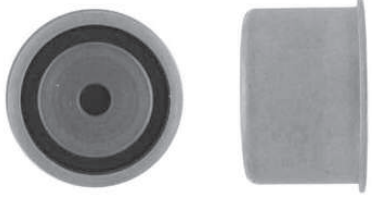

<p style="text-align: center;">HONDA</p>  <p>D x W = 55 x 24 mm</p> <p style="text-align: center;">BT HON13 HON103-22</p>	<p style="text-align: center;">HYUNDAI</p>  <p>D x W = 60 x 23 mm</p> <p style="text-align: center;">BT HYU01 HYU092-19</p>	<p style="text-align: center;">HYUNDAI</p>  <p>D x W = 60 x 27 mm</p> <p style="text-align: center;">BT HYU02 HYU092-22/HYU105</p>
<p style="text-align: center;">HYUNDAI</p>  <p>D x W = 70 x 27.5 mm</p> <p style="text-align: center;">BT HYU03 HYU111/HYU113</p>	<p style="text-align: center;">HYUNDAI</p>  <p style="text-align: center;">BT HYU04 HYU153</p>	<p style="text-align: center;">HYUNDAI</p>  <p>D x W = 60 x 31 mm</p> <p style="text-align: center;">BT HYU05 MIT122/HYU151</p>
<p style="text-align: center;">HYUNDAI</p>  <p>D x W = 60 x 32 mm</p> <p style="text-align: center;">BT HYU06 HYU151/HYU173/MIT123</p>	<p style="text-align: center;">HYUNDAI/COLT/MITSUBISHI</p>  <p>D x W = 60 x 32 mm</p> <p style="text-align: center;">BT HYU07 MIT149</p>	<p style="text-align: center;">HYUNDAI/COLT/MITSUBISHI</p>  <p>D x W = 60 x 29 mm</p> <p style="text-align: center;">BT HYU08 HYU163/COL163</p>
<p style="text-align: center;">HYUNDAI/COLT</p>  <p>D x W = 58 x 20 mm</p> <p style="text-align: center;">BT HYU09 HYU083</p>	<p style="text-align: center;">HYUNDAI</p>  <p>D x W = 55 x 25 mm</p> <p style="text-align: center;">BT HYU10 HYU105</p>	<p style="text-align: center;">HYUNDAI</p>  <p>D x W = 55 x 16 mm</p> <p style="text-align: center;">BT HYU11 HYU065-1995-1998</p>
<p style="text-align: center;">HYUNDAI/PROTON</p>  <p>D x W = 60 x 26 mm</p> <p style="text-align: center;">BT HYU12 HYU092-22-PROTON</p>	<p style="text-align: center;">HYUNDAI</p>  <p>D x W = 57 x 24 mm</p> <p style="text-align: center;">BT HYU13 HYU101</p>	<p style="text-align: center;">HYUNDAI</p>  <p>D x W = 58 x 37 mm</p> <p style="text-align: center;">BT HYU14 HYU207</p>

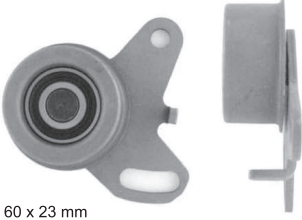
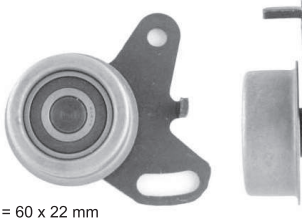

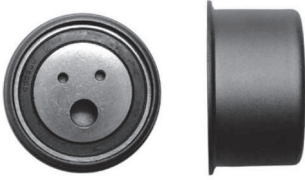



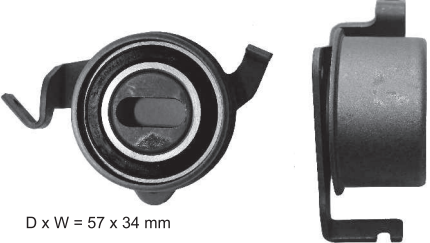

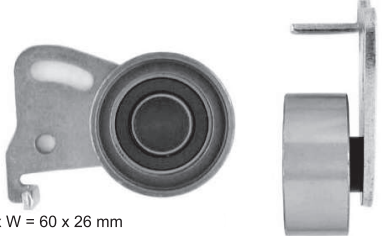
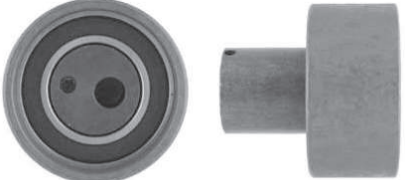
<p style="text-align: center;">HYUNDAI</p>  <p>D x W = 60 x 35 mm</p> <p style="text-align: center;">BT HYU15 HYU207</p>	<p style="text-align: center;">HYUNDAI</p>  <p>D x W = 60 x 31 mm</p> <p style="text-align: center;">BT HYU16 HYU173</p>	<p style="text-align: center;">HYUNDAI</p>  <p>D x W = 60 x 28 mm</p> <p style="text-align: center;">BT HYU17 HYU111/113</p>
<p style="text-align: center;">HYUNDAI</p>  <p>D x W = 70 x 31 mm</p> <p style="text-align: center;">BT HYU18 HYU111/113</p>	<p style="text-align: center;">HYUNDAI</p>  <p>D x W = 58 x 32 mm</p> <p style="text-align: center;">BT HYU19 HYU111/123</p>	<p style="text-align: center;">HYUNDAI</p>  <p>D x W = 58 x 32 mm</p> <p style="text-align: center;">BT HYU20 HYU123</p>
<p style="text-align: center;">ISUZU</p>  <p>D x W = 60 x 26 mm</p> <p style="text-align: center;">BT ISU01 ISU111/115/MAZ109S</p>	<p style="text-align: center;">ISUZU</p>  <p>D x W = 60 x 30 mm</p> <p style="text-align: center;">BT ISU02 ISU137-25</p>	<p style="text-align: center;">ISUZU</p>  <p>D x W = 60 x 37 mm</p> <p style="text-align: center;">BT ISU03 ISU087</p>
<p style="text-align: center;">ISUZU</p>  <p>D x W = 67 x 38 mm</p> <p style="text-align: center;">BT ISU04 ISU119</p>	<p style="text-align: center;">ISUZU</p>  <p>D x W = 67 x 38 mm</p> <p style="text-align: center;">BT ISU05 ISU119</p>	<p style="text-align: center;">ISUZU</p>  <p>D x W = 60 x 35 mm</p> <p style="text-align: center;">BT ISU06 ISU137-30</p>
<p style="text-align: center;">ISUZU</p>  <p>D x W = 60 x 35 mm</p> <p style="text-align: center;">BT ISU07 ISU137-30</p>	<p style="text-align: center;">ISUZU</p>  <p>D x W = 60 x 35 mm</p> <p style="text-align: center;">BT ISU08 ISU223</p>	<p style="text-align: center;">ISUZU</p>  <p>D x W = 70 x 36 mm</p> <p style="text-align: center;">BT ISU09 ISU223</p>

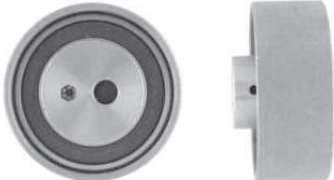

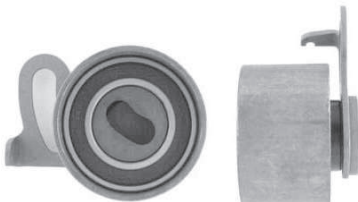

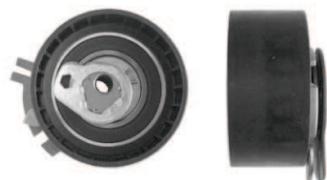
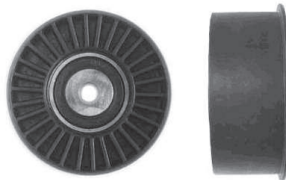
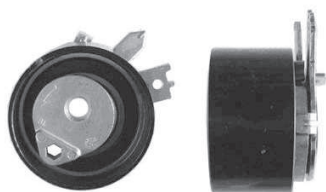
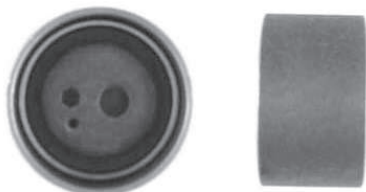

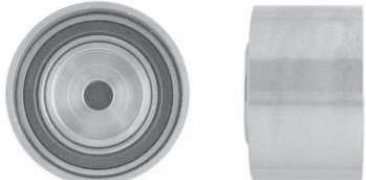

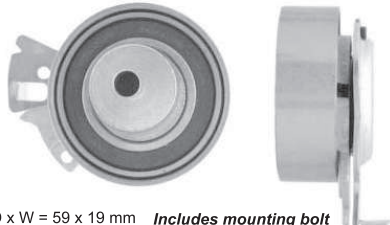
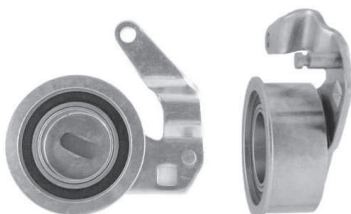

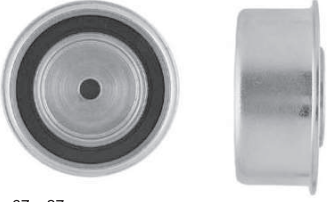
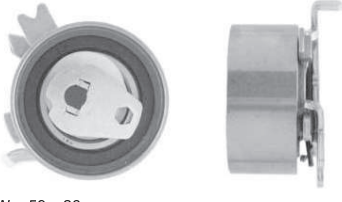
<p style="text-align: center;">IVECO</p>  <p>D x W = 64 x 34 mm</p> <p style="text-align: center;">BT IVE01 IVE152</p>	<p style="text-align: center;">IVECO</p>  <p>D x W = 67 x 34 mm</p> <p style="text-align: center;">BT IVE02 IVE152/IVE153/IVE154</p>	<p style="text-align: center;">KIA</p>  <p>D x W = 52 x 28 mm</p> <p style="text-align: center;">BT KIA01 KIA154</p>
<p style="text-align: center;">KIA</p>  <p>D x W = 60 x 32 mm</p> <p style="text-align: center;">BT KIA02 KIA176</p>	<p style="text-align: center;">KIA</p>  <p>D x W = 71 x 32 mm</p> <p style="text-align: center;">BT KIA03 KIA176</p>	<p style="text-align: center;">KIA</p>  <p>D x W = 60 x 26 mm</p> <p style="text-align: center;">BT KIA04 KIA059(2)</p>
<p style="text-align: center;">KIA</p>  <p>D x W = 60 x 26 mm</p> <p style="text-align: center;">BT KIA05 KIA059(2)</p>	<p style="text-align: center;">KIA</p>  <p>D x W = 60 x 34 mm</p> <p style="text-align: center;">BT KIA06 KIA151/KIA152</p>	<p style="text-align: center;">KIA</p>  <p>D x W = 55 x 34 mm</p> <p style="text-align: center;">BT KIA07 KIA151/KIA152</p>
<p style="text-align: center;">KIA</p>  <p>D x W = 60.5 x 33 mm</p> <p style="text-align: center;">BT KIA08 KIA151/KIA152</p>	<p style="text-align: center;">KIA/HYUNDAI</p>  <p>D x W = 59 x 34 mm</p> <p style="text-align: center;">BT KIA09 KIA152-HYUNDAI ENGINE</p>	<p style="text-align: center;">KIA/HYUNDAI</p>  <p>D x W = 29 x 34 mm</p> <p style="text-align: center;">BT KIA10 KIA152-HYUNDAI ENGINE</p>
<p style="text-align: center;">KIA</p>  <p>D x W = 58 x 32 mm</p> <p style="text-align: center;">BT KIA11 MAZ162-KIA ENGINE</p>	<p style="text-align: center;">LANCIA</p>  <p>D x W = 65 x 29 mm</p> <p style="text-align: center;">BT LAN01 LAN167</p>	<p style="text-align: center;">LANCIA</p>  <p>D x W = 54 x 29 mm</p> <p style="text-align: center;">BT LAN02 LAN167/FIA198-24/OPE-199</p>

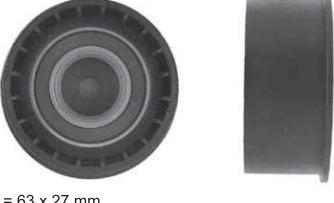
<p>MAZDA/FORD/KIA</p>  <p>D x W = 53 x 25 mm</p> <p>BT MAZ01 MAZ107-19/MAZ107-22A&B</p>	<p>MAZDA/FORD</p>  <p>D x W = 53 x 25 mm</p> <p>BT MAZ02 MAZ106R&S/MAZ109R&S</p>	<p>MAZDA/FORD/KIA</p>  <p>D x W = 52 x 28 mm</p> <p>BT MAZ03 MAZ104/MAZ108/MAZ110/MAZ168</p>
<p>MAZDA/FORD</p>  <p>D x W = 60 x 28 mm</p> <p>BT MAZ04 MAZ104/MAZ108/MAZ110</p>	<p>MAZDA</p>  <p>D x W = 60 x 30 mm</p> <p>BT MAZ05 MAZ168</p>	<p>MAZDA/FORD</p>  <p>D x W = 58 x 32 mm</p> <p>BT MAZ06 MAZ164</p>
<p>MAZDA/KIA</p>  <p>D x W = 52 x 25 mm</p> <p>BT MAZ07 MAZ123/MAZ125/MAZ145</p>	<p>MAZDA/KIA</p>  <p>D x W = 52 x 25 mm</p> <p>BT MAZ08 MAZ123/MAZ125/MAZ145/KIA154</p>	<p>MAZDA/FORD</p>  <p>D x W = 62 x 28 mm</p> <p>BT MAZ09 MAZ135</p>
<p>MAZDA/FORD</p>  <p>D x W = 60 x 33 mm</p> <p>BT MAZ10 MAZ192</p>	<p>MAZDA/FORD</p>  <p>D x W = 60 x 33 mm</p> <p>BT MAZ11 MAZ192</p>	<p>MAZDA/FORD</p>  <p>D x W = 60 x 32 mm</p> <p>BT MAZ12 MAZ192</p>
<p>MAZDA</p>  <p>D x W = 58 x 32 mm</p> <p>BT MAZ13 MAZ101</p>	<p>MAZDA</p>  <p>D x W = 62 x 28.5 mm</p> <p>BT MAZ14 MAZ133</p>	<p>MAZDA</p>  <p>D x W = 52 x 27 mm</p> <p>BT MAZ15 MAZ133/MAZ135</p>

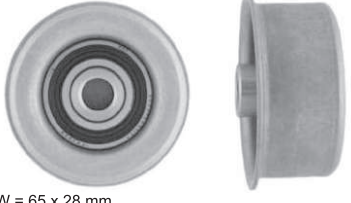

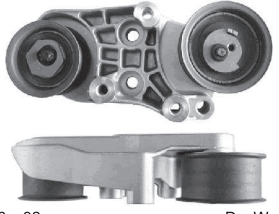
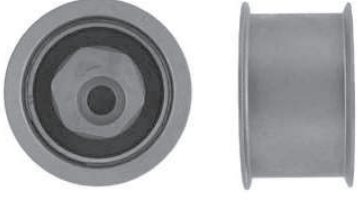

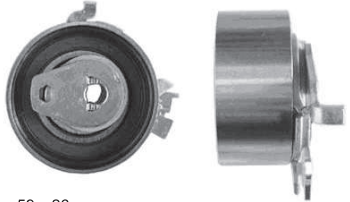

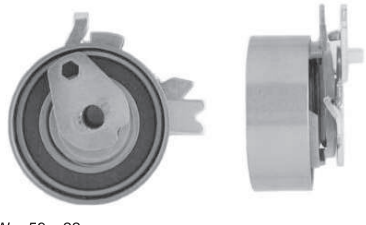
<p style="text-align: center;">MAZDA</p>  <p>D x W = 60 x 28 mm</p> <p style="text-align: center;">BT MAZ16 MAZ152</p>	<p style="text-align: center;">MAZDA</p>  <p>D x W = 58 x 32 mm</p> <p style="text-align: center;">BT MAZ17 MAZ162</p>	<p style="text-align: center;">MAZDA</p>  <p>D x W = 72 x 30 mm</p> <p style="text-align: center;">BT MAZ18 MAZ103</p>
<p style="text-align: center;">MAZDA</p>  <p>D x W = 58 x 30 mm</p> <p style="text-align: center;">BT MAZ19 MAZ103</p>	<p style="text-align: center;">MAZDA</p>  <p>D x W = 57 x 26 mm</p> <p style="text-align: center;">BT MAZ20 MAZ125</p>	<p style="text-align: center;">MAZDA</p>  <p>D x W = 57 x 32 mm</p> <p style="text-align: center;">BT MAZ21 MAZ101</p>
<p style="text-align: center;">MITSUBISHI/COLT</p>  <p>D x W = 60 x 23 mm</p> <p style="text-align: center;">BT MIT01 FOR122S/MIT120R/MIT120S</p>	<p style="text-align: center;">MITSUBISHI/COLT</p>  <p>D x W = 60 x 17 mm</p> <p style="text-align: center;">BT MIT02 COL055</p>	<p style="text-align: center;">MITSUBISHI/COLT/FORD</p>  <p>D x W = 60 x 22 mm</p> <p style="text-align: center;">BT MIT03 MIT122</p>
<p style="text-align: center;">MITSUBISHI/COLT/FORD</p>  <p>D x W = 60 x 18 mm</p> <p style="text-align: center;">BT MIT04 MIT055</p>	<p style="text-align: center;">MITSUBISHI</p>  <p>D x W = 60 x 23 mm</p> <p style="text-align: center;">BT MIT05 MIT092/HYU092-19</p>	<p style="text-align: center;">MITSUBISHI/COLT/HYUNDAI</p>  <p>D x W = 58 x 20 mm</p> <p style="text-align: center;">BT MIT06 COL099</p>
<p style="text-align: center;">MITSUBISHI/COLT/HYUNDAI</p>  <p>D x W = 55 x 16 mm</p> <p style="text-align: center;">BT MIT07 HYU065</p>	<p style="text-align: center;">MITSUBISHI/COLT/HYUNDAI</p>  <p>D x W = 60.5 x 31 mm</p> <p style="text-align: center;">BT MIT08 COL124/HYU153/MIT123</p>	<p style="text-align: center;">MITSUBISHI/COLT</p>  <p>D x W = 60 x 32 mm</p> <p style="text-align: center;">BT MIT09 COL124/HY153/MIT116/MIT123</p>

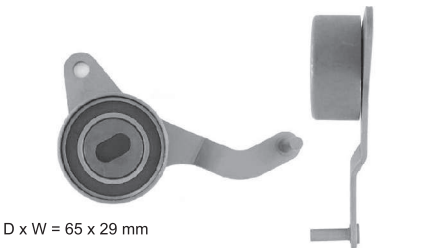
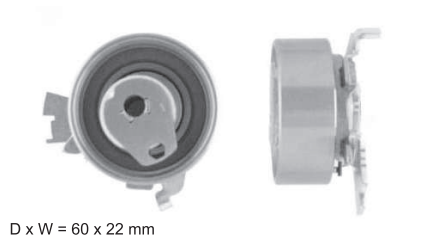
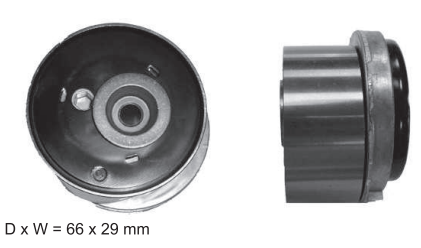
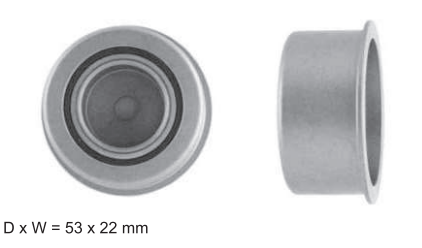
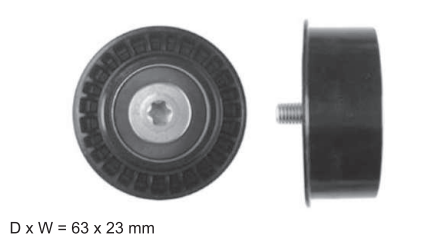
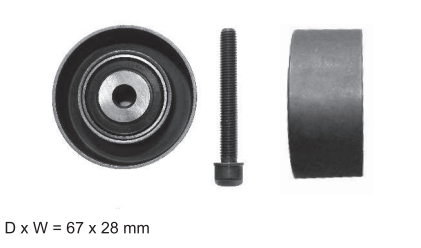
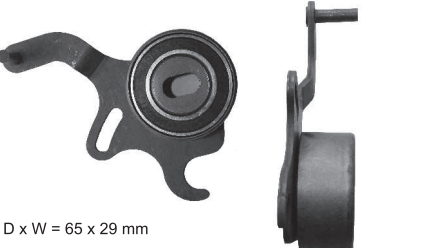
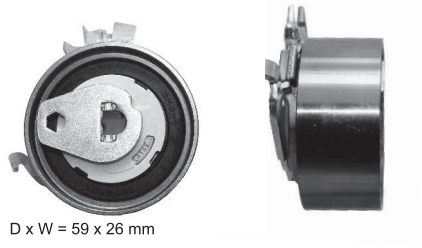
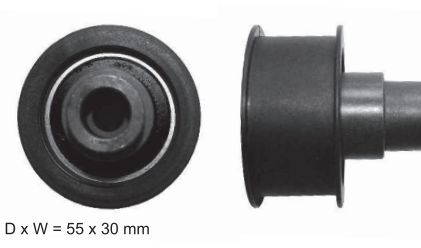
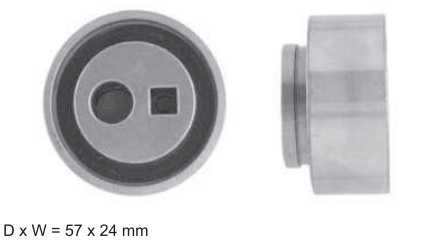
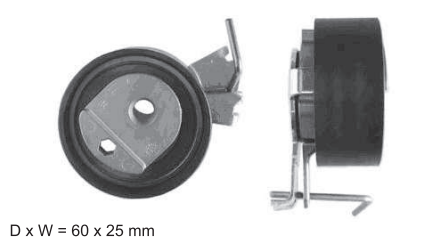
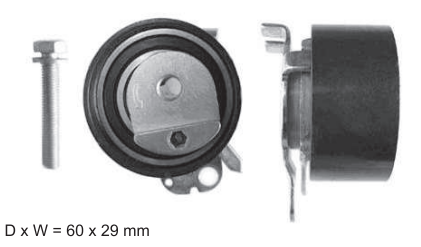

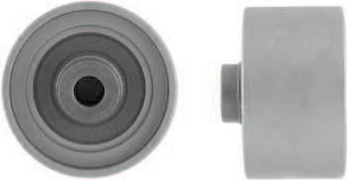

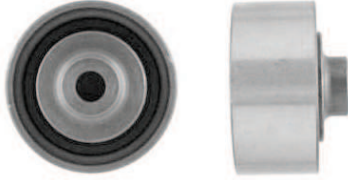
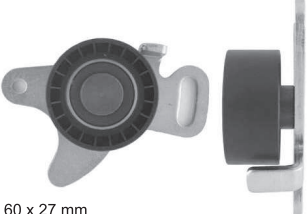
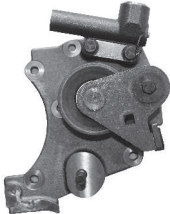
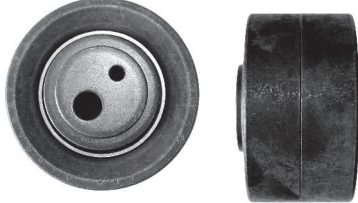
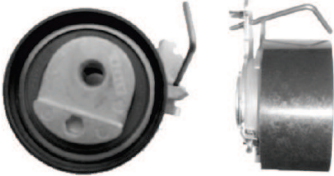

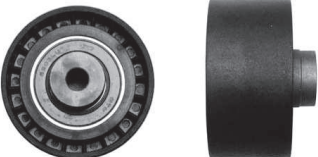
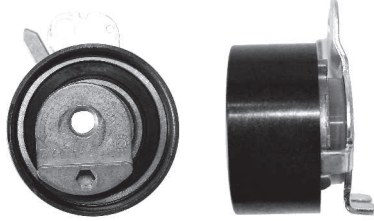
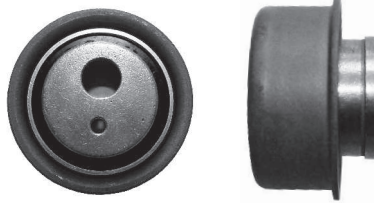
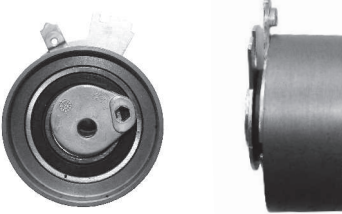
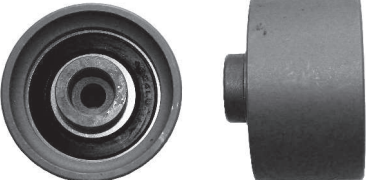

<p>MITSUBISHI/COLT</p>	<p>MITSUBISHI/COLT</p>	<p>MITSUBISHI/HYUNDAI</p>
 <p>D x W = 60 x 35 mm</p>	 <p>D x W = 58 x 36 mm</p>	 <p>D x W = 60 x 17 mm</p>
<p>BT MIT10 MIT187/MIT195/MIT201/MIT265</p>	<p>BT MIT11 MIT187/MIT195/MIT201/MIT265</p>	<p>BT MIT12 MIT055</p>
<p>MITSUBISHI/HYUNDAI</p>	<p>MITSUBISHI</p>	<p>MITSUBISHI</p>
 <p>D x W = 60 x 23 mm</p>	 <p>D x W = 60 x 22 mm</p>	
<p>BT MIT13 MIT122R-20</p>	<p>BT MIT14 MIT122R/MIT123-19</p>	<p>BT MIT15 COL24/MIT123</p>
<p>MITSUBISHI</p>	<p>MITSUBISHI</p>	<p>MITSUBISHI</p>
 <p>D x W = 58 x 31 mm</p>	 <p>D x W = 58 x 31 mm</p>	 <p>D x W = 57.5 x 28 mm</p>
<p>BT MIT16 MIT116/MIT159-29</p>	<p>BT MIT17 MIT111-29</p>	<p>BT MIT18 DAE109-MITSUBISHI ENGINE</p>
<p>MITSUBISHI</p>	<p>MITSUBISHI</p>	<p>MITSUBISHI</p>
 <p>D x W = 64 x 32 mm</p>	 <p>D x W = 57 x 34 mm</p>	 <p>D x W = 60 x 24 mm</p>
<p>BT MIT19 MIT159-29</p>	<p>BT MIT20 MIT121</p>	<p>BT MIT21 MIT120R</p>
<p>NISSAN</p>	<p>NISSAN</p>	<p>NISSAN</p>
 <p>D x W = 60 x 23 mm</p>	 <p>D x W = 60 x 26 mm</p>	 <p>D x W = 60 x 30 mm</p>
<p>BT NIS01 NIS102/MAZ106S</p>	<p>BT NIS02 NIS098</p>	<p>BT NIS03 NIS105/NIS115/NIS133R/NIS133S</p>



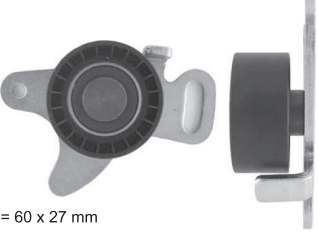
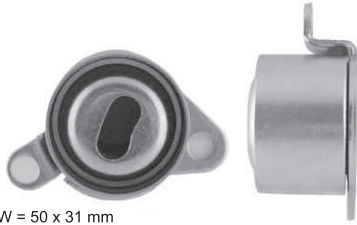
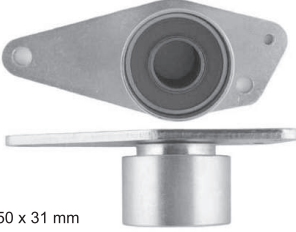
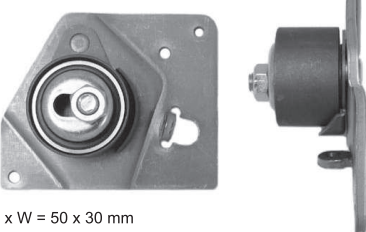

<p style="text-align: center;">NISSAN</p>  <p>D x W = 60 x 24 mm</p> <p style="text-align: center;">BT NIS04 NIS151</p>	<p style="text-align: center;">NISSAN</p>  <p>D x W = 53 x 25 mm</p> <p style="text-align: center;">BT NIS05 NIS151</p>	<p style="text-align: center;">NISSAN</p> <p style="text-align: center;"><i>TO BE ALLOCATED</i></p> <p style="text-align: center;">BT NIS06 T.B.A.</p>
<p style="text-align: center;">NISSAN</p>  <p>D x W = 60 x 36 mm</p> <p style="text-align: center;">BT NIS07 NIS149</p>	<p style="text-align: center;">NISSAN</p>  <p>D x W = 60 x 36 mm</p> <p style="text-align: center;">BT NIS08 NIS149</p>	<p style="text-align: center;">NISSAN</p>  <p>D x W = 70 x 32 mm</p> <p style="text-align: center;">BT NIS09 NIS089</p>
<p style="text-align: center;">NISSAN</p>  <p>D x W = 78 x 30 mm</p> <p style="text-align: center;">BT NIS10 NIS089</p>	<p style="text-align: center;">NISSAN/RENAULT</p>  <p>D x W = 60 x 32 mm</p> <p style="text-align: center;">BT NIS11 NIS123</p>	<p style="text-align: center;">NISSAN</p>  <p>D x W = 60 x 35 mm</p> <p style="text-align: center;">BT NIS12 NIS141</p>
<p style="text-align: center;">NISSAN</p>  <p>D x W = 60 x 35 mm</p> <p style="text-align: center;">BT NIS13 NIS141</p>	<p style="text-align: center;">NISSAN</p>  <p>D x W = 60 x 36 mm</p> <p style="text-align: center;">BT NIS14 NIS228</p>	<p style="text-align: center;">NISSAN</p>  <p>D x W = 60 x 36 mm</p> <p style="text-align: center;">BT NIS15 NIS228</p>
<p style="text-align: center;">NISSAN</p>  <p>D x W = 60 x 36 mm</p> <p style="text-align: center;">BT NIS16 NIS228</p>	<p style="text-align: center;">OPEL/CHEV/DAEWOO</p>  <p>D x W = 59 x 19 mm <i>Includes mounting bolt</i></p> <p style="text-align: center;">BT OPE01 OPE111-17</p>	<p style="text-align: center;">OPEL/CHEV/DAEWOO</p>  <p>D x W = 67 x 27 mm</p> <p style="text-align: center;">BT OPE02 OPE141</p>



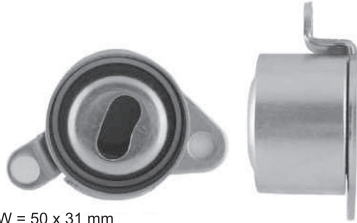
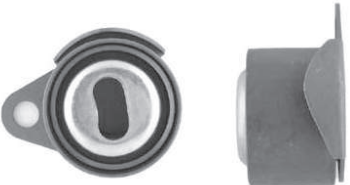
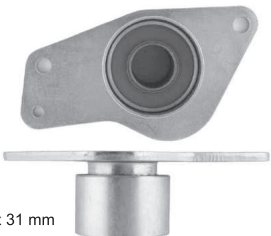
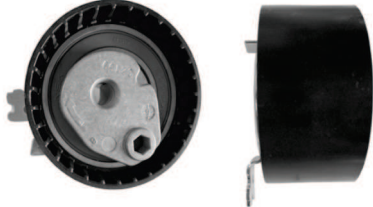

OPEL	OPEL/CHEV	OPEL
 <p>D x W = 67 x 27 mm</p> <p>BT OPE03 OPE141</p>	 <p>D x W = 59 x 26 mm</p> <p>BT OPE04 OPE169-24/OPE171/OPE176</p>	 <p>D x W = 53 x 27 mm</p> <p>BT OPE05 OPE169-24/OPE171/OPE176</p>
OPEL	OPEL	OPEL
 <p>D x W = 63 x 27 mm</p> <p>BT OPE06 OPE176</p>	 <p>D x W = 65 x 28 mm</p> <p>BT OPE07 OPE136</p>	 <p>D x W = 65 x 28 mm</p> <p>BT OPE08 OPE136</p>
OPEL	OPEL	OPEL
 <p>D x W = 53 x 23 mm</p> <p>BT OPE09 OPE162/OPE169-20</p>	 <p>D x W = 63 x 23 mm</p> <p>BT OPE10 OPE169-20</p>	 <p>D x W = 56 x 32 mm D x W = 66 x 32 mm</p> <p>BT OPE11 OPE225</p>
OPEL	OPEL	OPEL
 <p>D x W = 57 x 32 mm</p> <p>BT OPE12 OPE225</p>	 <p>D x W = 65 x 28 mm</p> <p>BT OPE13 OPE131</p>	 <p>D x W = 65 x 27 mm</p> <p>BT OPE14 OPE131</p>
OPEL	OPEL	OPEL
 <p>D x W = 59 x 26 mm</p> <p>BT OPE15 OPE168/OPE171</p>	 <p>D x W = 53 x 27 mm</p> <p>BT OPE16 OPE168/OPE171</p>	 <p>D x W = 59 x 22 mm</p> <p>BT OPE17 OPE146-20/ISU148</p>

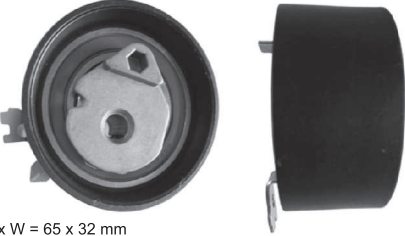
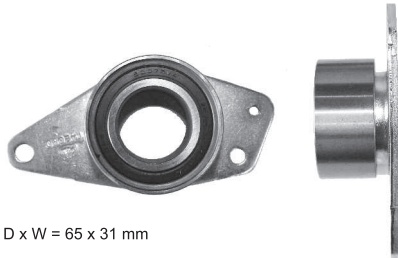
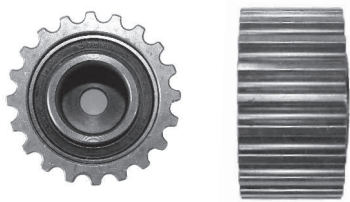
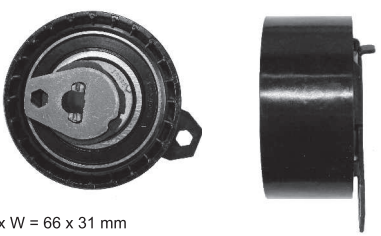
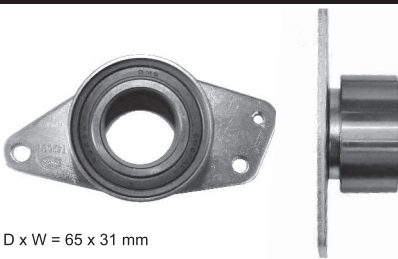
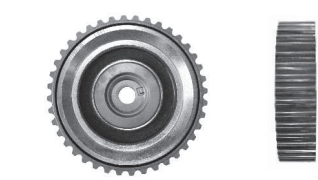
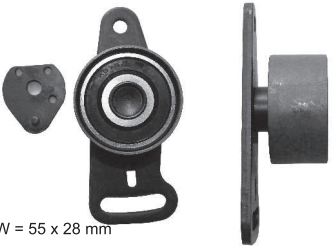
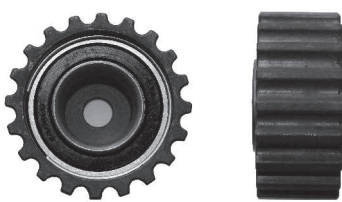
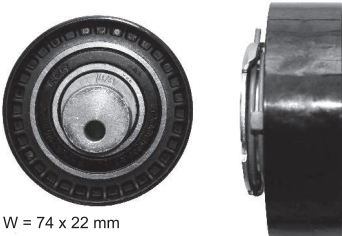
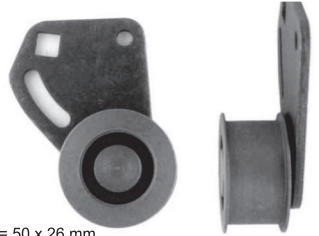
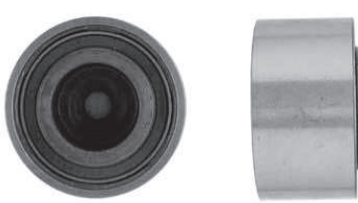
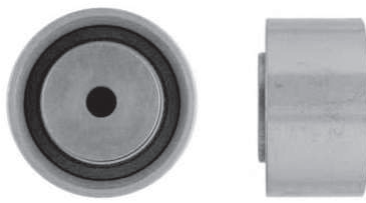



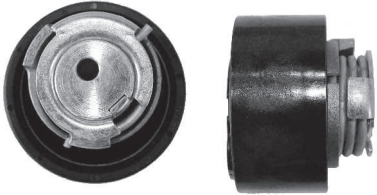
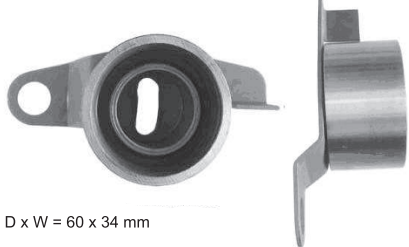

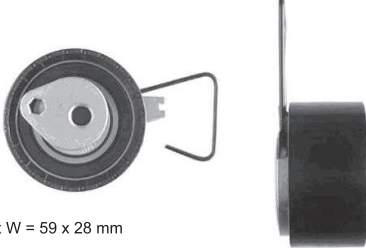
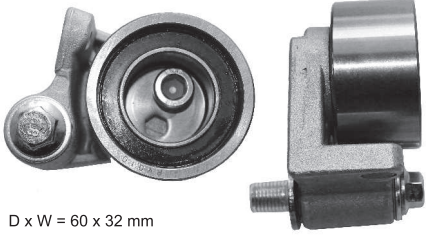
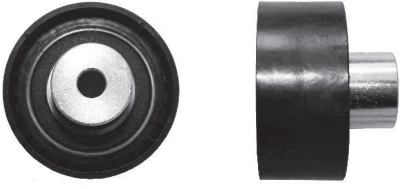

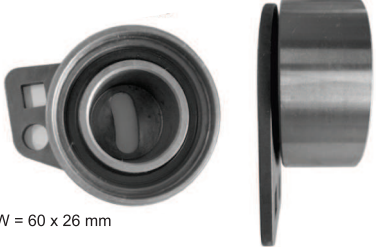
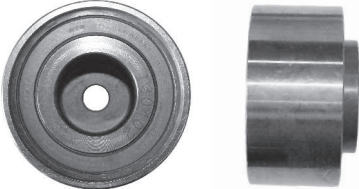
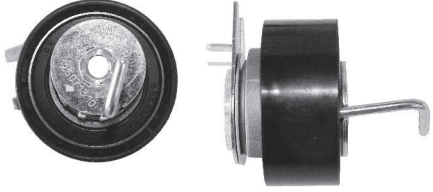
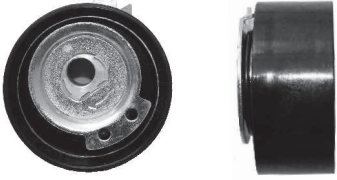
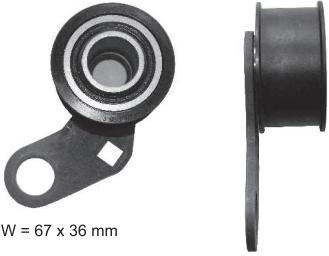
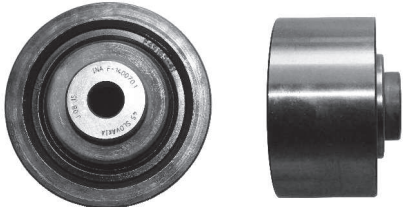
<p style="text-align: center;">OPEL</p>  <p>D x W = 65 x 29 mm</p> <p style="text-align: center;">BT OPE18 OPE136</p>	<p style="text-align: center;">OPEL</p>  <p>D x W = 60 x 22 mm</p> <p style="text-align: center;">BT OPE19 OPE162/OPE169-20</p>	<p style="text-align: center;">OPEL</p>  <p>D x W = 66 x 29 mm</p> <p style="text-align: center;">BT OPE20 OPE146-24</p>
<p style="text-align: center;">OPEL</p>  <p>D x W = 53 x 22 mm</p> <p style="text-align: center;">BT OPE21 OPE 162</p>	<p style="text-align: center;">OPEL</p>  <p>D x W = 63 x 23 mm</p> <p style="text-align: center;">BT OPE22 OPE162</p>	<p style="text-align: center;">OPEL</p>  <p>D x W = 67 x 28 mm</p> <p style="text-align: center;">BT OPE23 OPE146-24</p>
<p style="text-align: center;">OPEL</p>  <p>D x W = 65 x 29 mm</p> <p style="text-align: center;">BT OPE24 OPE136</p>	<p style="text-align: center;">OPEL</p>  <p>D x W = 59 x 26 mm</p> <p style="text-align: center;">BT OPE25 OPE168</p>	<p style="text-align: center;">OPEL</p>  <p>D x W = 55 x 30 mm</p> <p style="text-align: center;">BT OPE26 OPE176</p>
<p style="text-align: center;">OPEL</p> <p style="text-align: center;"><i>PHOTO NOT AVAILABLE</i></p> <p style="text-align: center;">BT OPE27 OPE225</p>	<p style="text-align: center;">OPEL</p> <p style="text-align: center;"><i>PHOTO NOT AVAILABLE</i></p> <p style="text-align: center;">BT OPE28 OPE225</p>	<p style="text-align: center;">OPEL</p> <p style="text-align: center;"><i>PHOTO NOT AVAILABLE</i></p> <p style="text-align: center;">BT OPE29 OPE225</p>
<p style="text-align: center;">PEUGEOT/CITROEN/FIAT</p>  <p>D x W = 57 x 24 mm</p> <p style="text-align: center;">BT PEU01 PEU101/PEU108/PEU114</p>	<p style="text-align: center;">PEUGEOT/CITROEN</p>  <p>D x W = 60 x 25 mm</p> <p style="text-align: center;">BT PEU02 CIT100/CIT104/PEU104</p>	<p style="text-align: center;">PEUGEOT</p>  <p>D x W = 60 x 29 mm</p> <p style="text-align: center;">BT PEU03 PEU136</p>



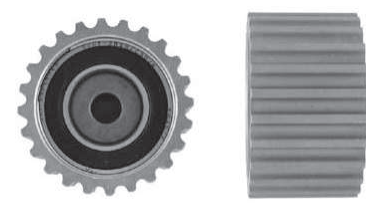
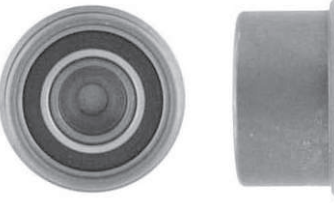
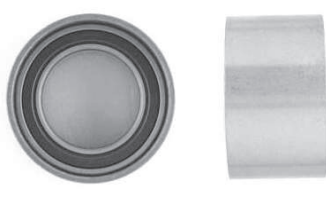

<p style="text-align: center;">PEUGEOT</p>  <p>D x W = 60 x 34 mm</p> <p style="text-align: center;">BT PEU04 PEU136/TAT136</p>	<p style="text-align: center;">PEUGEOT</p>  <p>D x W = 58 x 29 mm</p> <p style="text-align: center;">BT PEU05 PEU136</p>	<p style="text-align: center;">PEUGEOT</p>  <p>D x W = 60 x 29 mm</p> <p style="text-align: center;">BT PEU06 PEU136</p>
<p style="text-align: center;">PEUGEOT</p>  <p>D x W = 60 x 27 mm</p> <p style="text-align: center;">BT PEU07 PEU116/PEU118R/PEU118S</p>	<p style="text-align: center;">PEUGEOT</p>  <p>D x W = 71 x 38 mm</p> <p style="text-align: center;">BT PEU08 PEU147</p>	<p style="text-align: center;">PEUGEOT</p>  <p>D x W = 71 x 38 mm</p> <p style="text-align: center;">BT PEU09 PEU147</p>
<p style="text-align: center;">PEUGEOT</p>  <p>D x W = 60 x 29 mm</p> <p style="text-align: center;">BT PEU10 PEU135</p>	<p style="text-align: center;">PEUGEOT</p>  <p>D x W = 60 x 30 mm</p> <p style="text-align: center;">BT PEU11 PEU135</p>	<p style="text-align: center;">PEUGEOT</p>  <p>D x W = 70 x 30 mm</p> <p style="text-align: center;">BT PEU12 PEU134</p>
<p style="text-align: center;">PEUGEOT</p>  <p>D x W = 60 x 30 mm</p> <p style="text-align: center;">BT PEU13 PEU134</p>	<p style="text-align: center;">PEUGEOT</p>  <p>D x W = 60 x 29 mm</p> <p style="text-align: center;">BT PEU14 PEU136</p>	<p style="text-align: center;">PEUGEOT</p>  <p>D x W = 58 x 26 mm</p> <p style="text-align: center;">BT PEU15 PEU114</p>
<p style="text-align: center;">PEUGEOT</p>  <p>D x W = 73 x 30 mm</p> <p style="text-align: center;">BT PEU16 PEU134</p>	<p style="text-align: center;">PEUGEOT</p>  <p>D x W = 57 x 32 mm</p> <p style="text-align: center;">BT PEU17 PEU134</p>	<p style="text-align: center;">PROTON</p>  <p>D x W = 60 x 28 mm</p> <p style="text-align: center;">BT PRO01 PRO144</p>

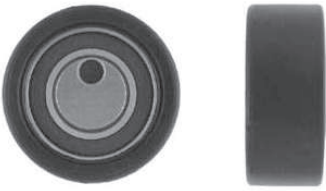
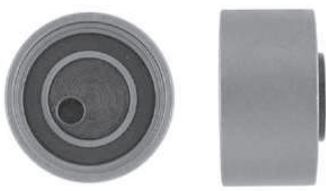
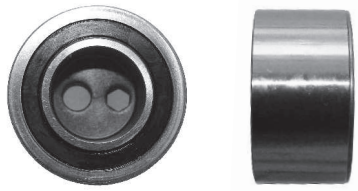
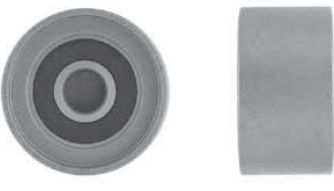

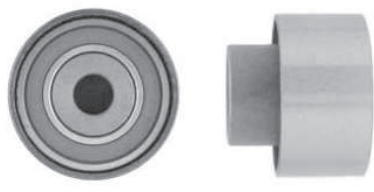

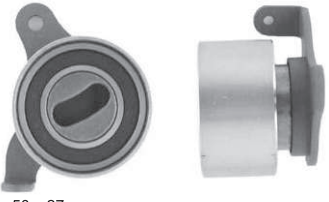
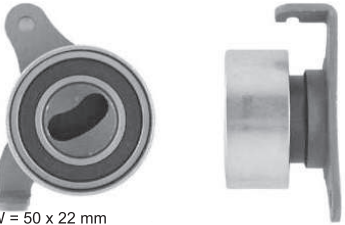
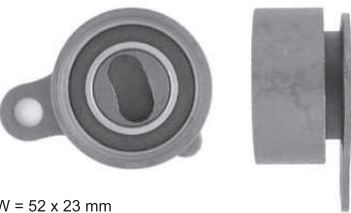
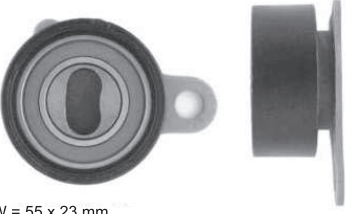

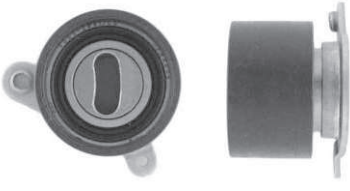

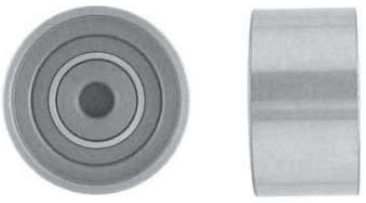
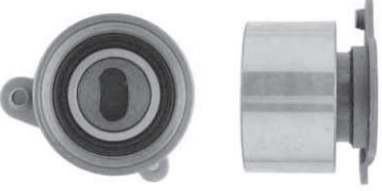
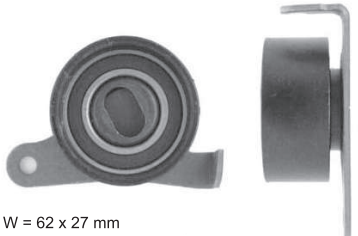
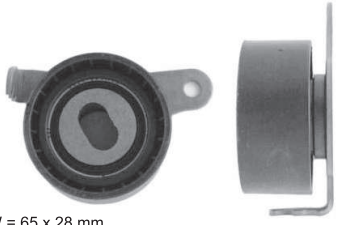
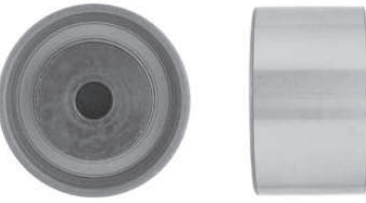
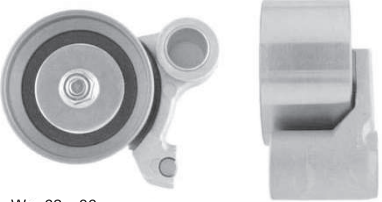
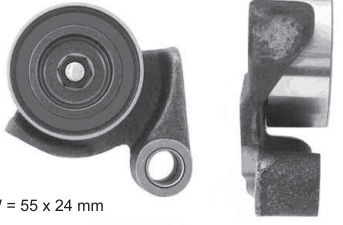
<p>RENAULT</p>	<p>RENAULT</p>	<p>RENAULT</p>
 <p>D x W = 50 x 31 mm</p>	 <p>D x W = 50 x 31 mm</p>	 <p>D x W = 50 x 22 mm</p>
<p>BT REN01 REN124</p>	<p>BT REN02 REN124</p>	<p>BT REN03 REN087/REN095-17</p>
<p>RENAULT</p>	<p>RENAULT</p>	<p>RENAULT</p>
 <p>D x W = 55 x 22 mm</p>	 <p>D x W = 60 x 27 mm</p>	 <p>D x W = 50 x 31 mm</p>
<p>BT REN04 REN096</p>	<p>BT REN05 REN116</p>	<p>BT REN06 REN125/REN127/REN151/REN153-26A</p>
<p>RENAULT</p>	<p>RENAULT</p>	<p>RENAULT</p>
 <p>D x W = 50 x 31 mm</p>	 <p>D x W = 50 x 30 mm</p>	 <p>D x W = 66 x 32 mm</p>
<p>BT REN07 REN125/REN127</p>	<p>BT REN08 OPE132-26/REN132</p>	<p>BT REN09 REN126/REN128/REN134-27</p>
<p>RENAULT</p>	<p>RENAULT</p>	<p>RENAULT</p>
 <p>D x W = 54 x 32 mm 17 mm hole</p>	 <p>D x W = 54 x 32 mm</p>	 <p>D x W = 50 x 31 mm</p>
<p>BT REN10 REN126/REN128</p>	<p>BT REN11 REN128/REN134-27</p>	<p>BT REN12 REN133</p>
<p>RENAULT</p>	<p>RENAULT</p>	<p>RENAULT</p>
 <p>D x W = 50 x 31 mm</p>	 <p>D x W = 50 x 31 mm</p>	 <p>D x W = 65.5 x 32 mm</p>
<p>BT REN13 REN148</p>	<p>BT REN14 REN148/REN151</p>	<p>BT REN15 REN132 PETROL ENGINE</p>

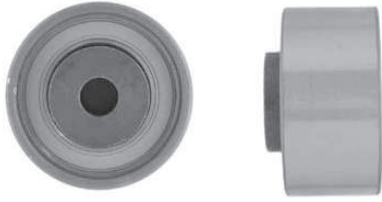

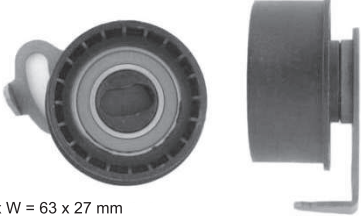
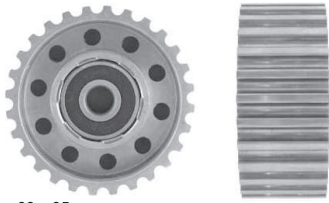
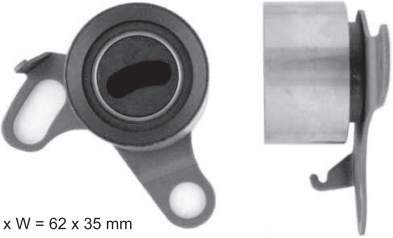

<p style="text-align: center;">RENAULT</p>  <p>D x W = 54 x 32 mm 10 mm hole</p> <p style="text-align: center;">BT REN16 REN126/REN132/REN134-27</p>	<p style="text-align: center;">RENAULT</p>  <p>D x W = 59 x 28.5 mm</p> <p style="text-align: center;">BT REN17 REN095-23</p>	<p style="text-align: center;">RENAULT</p>  <p>D x W = 65 x 32 mm</p> <p style="text-align: center;">BT REN18 REN132 PETROL ENGINE</p>
<p style="text-align: center;">RENAULT</p>  <p>D x W = 65 x 31 mm</p> <p style="text-align: center;">BT REN19 REN153-26A</p>	<p style="text-align: center;">RENAULT</p>  <p>D x W = 59 x 31 mm</p> <p style="text-align: center;">BT REN20 REN153-26A/REN153-26B</p>	<p style="text-align: center;">RENAULT</p>  <p>D x W = 66 x 31 mm</p> <p style="text-align: center;">BT REN21 REN153-26B</p>
<p style="text-align: center;">RENAULT</p>  <p>D x W = 65 x 31 mm</p> <p style="text-align: center;">BT REN22 REN153-26B</p>	<p style="text-align: center;">RENAULT</p>  <p>D x W = 120 x 31 mm</p> <p style="text-align: center;">BT REN23 REN153-26B</p>	<p style="text-align: center;">RENAULT</p>  <p>D x W = 55 x 28 mm</p> <p style="text-align: center;">BT REN24 REN116</p>
<p style="text-align: center;">RENAULT</p>  <p>D x W = 65 x 25 mm</p> <p style="text-align: center;">BT REN25 REN127</p>	<p style="text-align: center;">RENAULT</p>  <p>D x W = 74 x 22 mm</p> <p style="text-align: center;">BT REN26 REN096-17.3</p>	<p style="text-align: center;">LAND ROVER</p>  <p>D x W = 50 x 26 mm</p> <p style="text-align: center;">BT ROV01 ROV128</p>
<p style="text-align: center;">LAND ROVER</p>  <p>D x W = 60 x 32 mm</p> <p style="text-align: center;">BT ROV02 ROV109</p>	<p style="text-align: center;">LAND ROVER</p>  <p>D x W = 65 x 35 mm</p> <p style="text-align: center;">BT ROV03 ROV109/ROV118</p>	<p style="text-align: center;">LAND ROVER</p>  <p>D x W = 67 x 38 mm</p> <p style="text-align: center;">BT ROV04 ROV118</p>

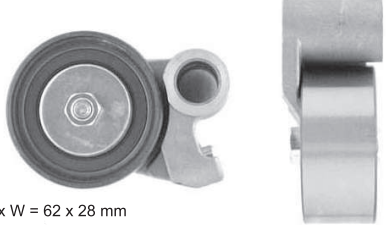
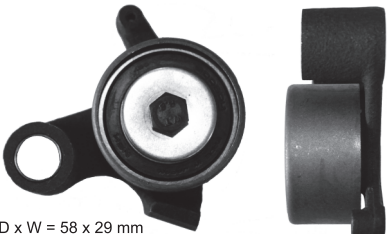
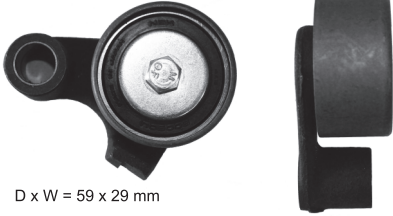
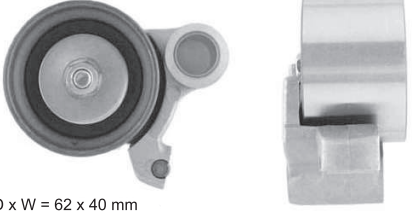
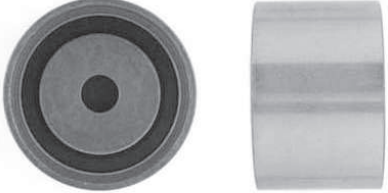
<p style="text-align: center;">LAND ROVER</p>  <p>D x W = 69 x 34 mm</p> <p style="text-align: center;">BT ROV05 ROV195</p>	<p style="text-align: center;">LAND ROVER</p>  <p>D x W = 60 x 34 mm</p> <p style="text-align: center;">BT ROV06 ROV112-30</p>	<p style="text-align: center;">LAND ROVER</p>  <p>D x W = 60 x 34 mm</p> <p style="text-align: center;">BT ROV07 ROV112-30</p>
<p style="text-align: center;">LAND ROVER/MG ROVER</p>  <p>D x W = 56 x 32 mm</p> <p style="text-align: center;">BT ROV08 ROV143-23/ROV143-26</p>	<p style="text-align: center;">LAND ROVER/MG ROVER</p>  <p>D x W = 59 x 28 mm</p> <p style="text-align: center;">BT ROV09 ROV145</p>	<p style="text-align: center;">LAND ROVER/MG ROVER</p>  <p>D x W = 60 x 32 mm</p> <p style="text-align: center;">BT ROV10 ROV176</p>
<p style="text-align: center;">LAND ROVER/MG ROVER</p>  <p>D x W = 70 x 32 mm</p> <p style="text-align: center;">BT ROV11 ROV176</p>	<p style="text-align: center;">LAND ROVER/MG ROVER</p>  <p>D x W = 60 x 32 mm</p> <p style="text-align: center;">BT ROV12 ROV112-28</p>	<p style="text-align: center;">LAND ROVER/MG ROVER</p>  <p>D x W = 60 x 32 mm</p> <p style="text-align: center;">BT ROV13 ROV112-28</p>
<p style="text-align: center;">LAND ROVER/MG ROVER</p>  <p>D x W = 60 x 26 mm</p> <p style="text-align: center;">BT ROV14 ROV078-22/ROV078-24</p>	<p style="text-align: center;">LAND ROVER/MG ROVER</p>  <p>D x W = 69 x 34 mm</p> <p style="text-align: center;">BT ROV15 ROV195</p>	<p style="text-align: center;">LAND ROVER/MG ROVER</p>  <p>D x W = 60 x 26 mm</p> <p style="text-align: center;">BT ROV16 ROV085</p>
<p style="text-align: center;">LAND ROVER/MG ROVER</p>  <p>D x W = 60 x 26 mm</p> <p style="text-align: center;">BT ROV17 ROV078-24</p>	<p style="text-align: center;">LAND ROVER/MG ROVER</p>  <p>D x W = 67 x 36 mm</p> <p style="text-align: center;">BT ROV18 ROV118</p>	<p style="text-align: center;">LAND ROVER/MG ROVER</p>  <p>D x W = 64 x 35 mm</p> <p style="text-align: center;">BT ROV19 ROV118</p>

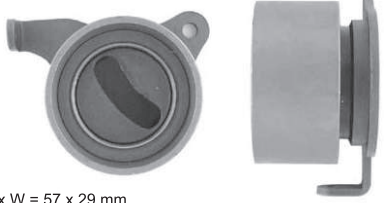

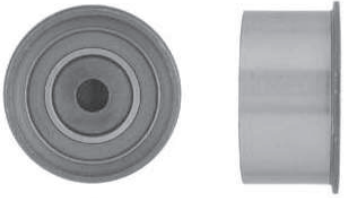
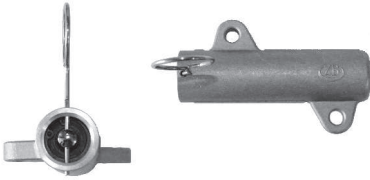

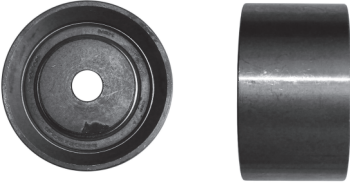
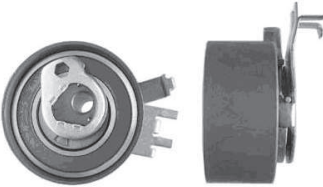
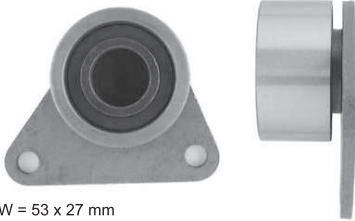
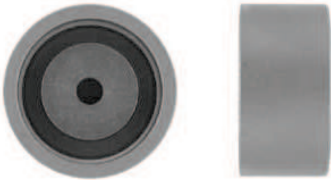
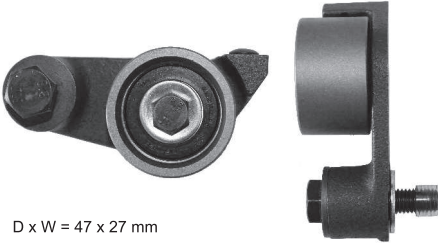
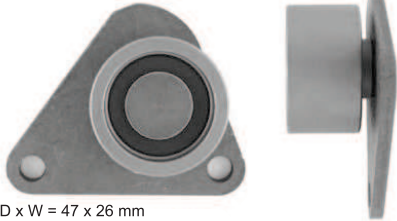
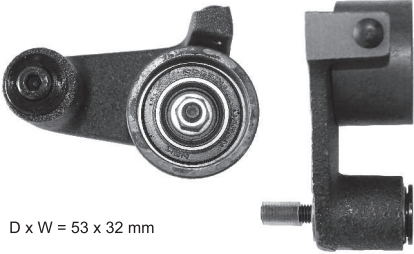
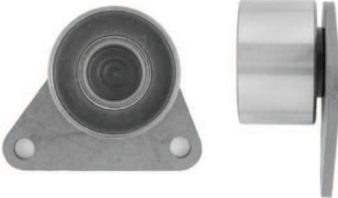
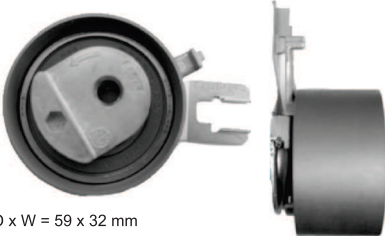

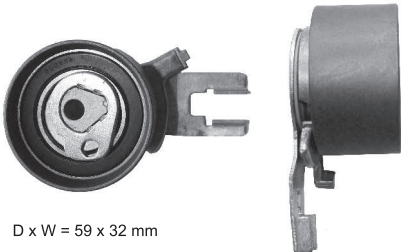
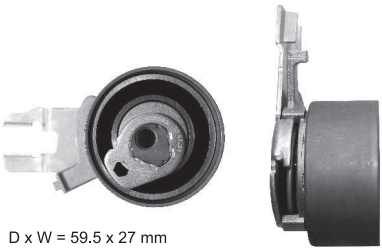

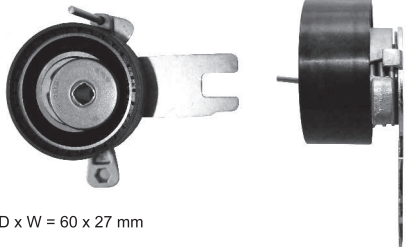
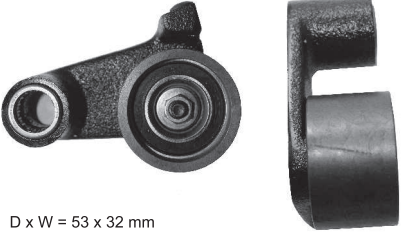
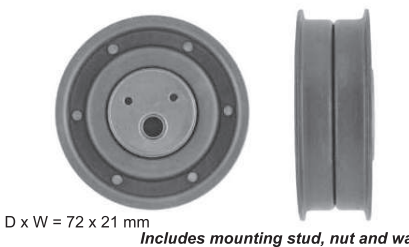
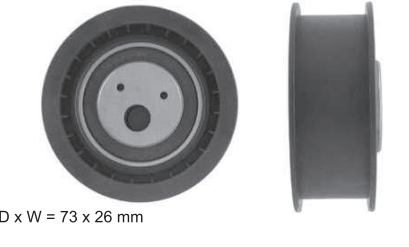
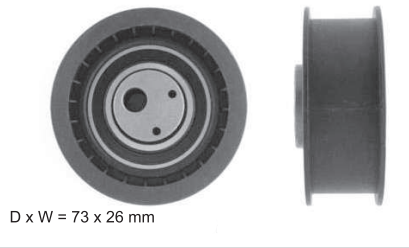
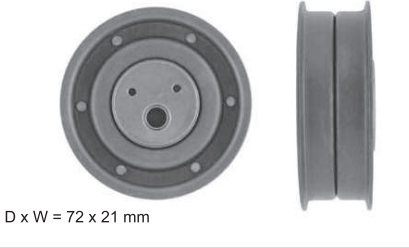
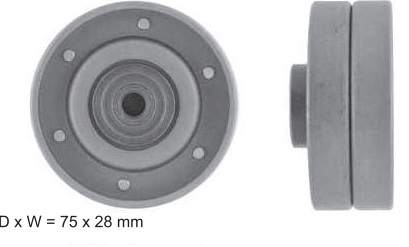
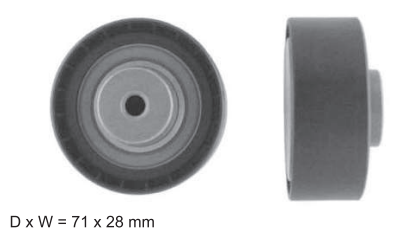
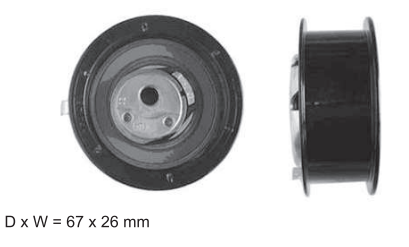
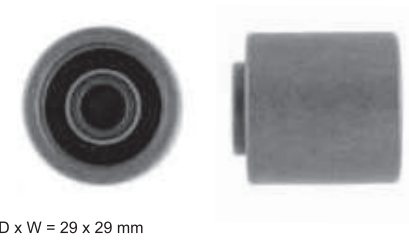
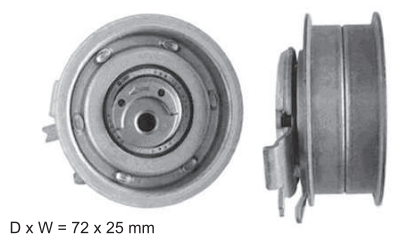
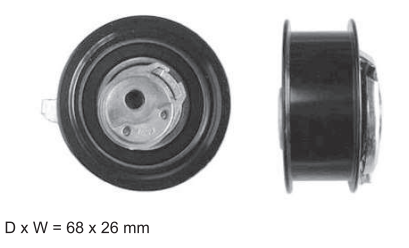
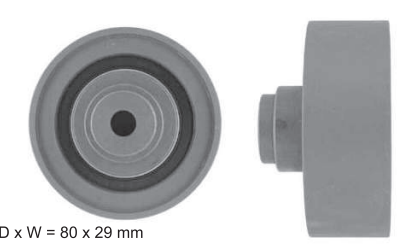
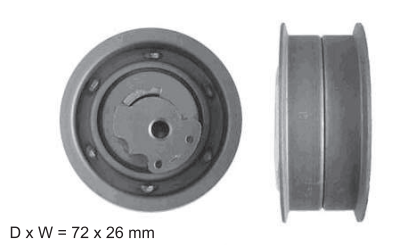
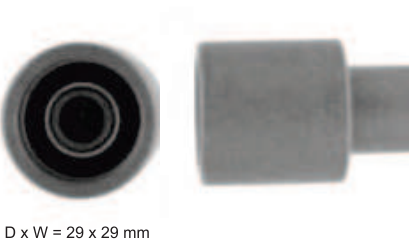
<p style="text-align: center;">SUBARU</p>  <p>D x W = 70 x 34 mm</p> <p style="text-align: center;">BT SUB01 SUB211</p>	<p style="text-align: center;">SUBARU</p>  <p>D x W = 60 x 35 mm</p> <p style="text-align: center;">BT SUB02 SUB211/SUB223/SUB281</p>	<p style="text-align: center;">SUBARU</p>  <p>D x W = 60 x 35 mm</p> <p style="text-align: center;">BT SUB03 SUB211/SUB223/SUB281</p>
<p style="text-align: center;">SUBARU</p>  <p>D x W = 60 x 31 mm</p> <p style="text-align: center;">BT SUB04 SUB223</p>	<p style="text-align: center;">SUBARU</p>  <p>D x W = 60 x 35 mm</p> <p style="text-align: center;">BT SUB05 SUB223/SUB281</p>	<p style="text-align: center;">SUBARU</p>  <p>D x W = 60 x 35 mm</p> <p style="text-align: center;">BT SUB06 SUB281</p>
<p style="text-align: center;">SUBARU</p>  <p>D x W = 31 x 34 mm</p> <p style="text-align: center;">BT SUB07 SUB281</p>	<p style="text-align: center;">SUZUKI</p>  <p>D x W = 52 x 23 mm</p> <p style="text-align: center;">BT SUZ01 HON084/TOY88</p>	<p style="text-align: center;">SUZUKI</p>  <p>D x W = 43 x 24 mm</p> <p style="text-align: center;">BT SUZ02 SUZ097-19</p>
<p style="text-align: center;">SUZUKI</p>  <p>D x W = 58 x 24 mm</p> <p style="text-align: center;">BT SUZ03 SUZ089/SUZ089R/SUZ095</p>	<p style="text-align: center;">SUZUKI</p>  <p>D x W = 52 x 27 mm</p> <p style="text-align: center;">BT SUZ04 SUZ097-25/SUZ103</p>	<p style="text-align: center;">TATA</p>  <p>D x W = 60 x 32 mm</p> <p style="text-align: center;">BT TAT01 TAT136</p>
<p style="text-align: center;">TOYOTA</p>  <p>D x W = 50 x 27 mm</p> <p style="text-align: center;">BT TOY01 TOY123-24</p>	<p style="text-align: center;">TOYOTA</p>  <p>D x W = 50 x 23 mm</p> <p style="text-align: center;">BT TOY01A TOY123-20</p>	<p style="text-align: center;">TOYOTA</p>  <p>D x W = 51 x 27 mm</p> <p style="text-align: center;">BT TOY01B TOY127R</p>

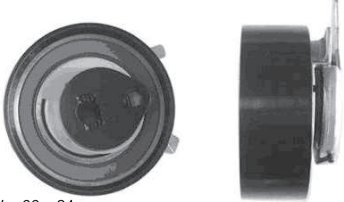
<p style="text-align: center;">TOYOTA</p>  <p>D x W = 50 x 27 mm</p> <p style="text-align: center;">BT TOY02 TOY123-24/TOY127R</p>	<p style="text-align: center;">TOYOTA</p>  <p>D x W = 50 x 22 mm</p> <p style="text-align: center;">BT TOY02A TOY123-20</p>	<p style="text-align: center;">TOYOTA</p>  <p>D x W = 52 x 23 mm</p> <p style="text-align: center;">BT TOY03 TOY088/TOY094S</p>
<p style="text-align: center;">TOYOTA</p>  <p>D x W = 55 x 23 mm</p> <p style="text-align: center;">BT TOY04 TOY113</p>	<p style="text-align: center;">TOYOTA</p>  <p>D x W = 57 x 25 mm</p> <p style="text-align: center;">BT TOY05 TOY117/TOY121</p>	<p style="text-align: center;">TOYOTA</p>  <p>D x W = 58 x 29 mm</p> <p style="text-align: center;">BT TOY06 TOY131/TOY163/TOY178/TOY177-3SGE</p>
<p style="text-align: center;">TOYOTA</p>  <p>D x W = 52 x 31 mm</p> <p style="text-align: center;">BT TOY07 TOY131/BMW111</p>	<p style="text-align: center;">TOYOTA</p>  <p>D x W = 58 x 29 mm</p> <p style="text-align: center;">BT TOY08 TOY163</p>	<p style="text-align: center;">TOYOTA</p>  <p>D x W = 58 x 32 mm</p> <p style="text-align: center;">BT TOY09 TOY129-27</p>
<p style="text-align: center;">TOYOTA</p>  <p>D x W = 54 x 32 mm</p> <p style="text-align: center;">BT TOY10 TOY129-27</p>	<p style="text-align: center;">TOYOTA</p>  <p>D x W = 62 x 27 mm</p> <p style="text-align: center;">BT TOY11 TOY142/TOY169</p>	<p style="text-align: center;">TOYOTA</p>  <p>D x W = 65 x 28 mm</p> <p style="text-align: center;">BT TOY12 TOY159</p>
<p style="text-align: center;">TOYOTA</p>  <p>D x W = 62 x 36 mm</p> <p style="text-align: center;">BT TOY13 TOY191/TOY211</p>	<p style="text-align: center;">TOYOTA</p>  <p>D x W = 62 x 36 mm</p> <p style="text-align: center;">BT TOY14 TOY191/TOY211</p>	<p style="text-align: center;">TOYOTA</p>  <p>D x W = 55 x 24 mm</p> <p style="text-align: center;">BT TOY15 TOY110/TOY111</p>

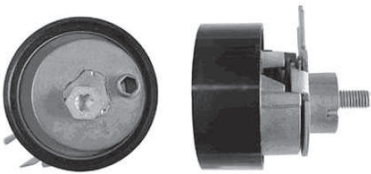
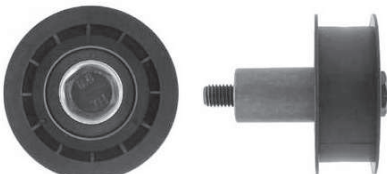
<p style="text-align: center;">TOYOTA</p>  <p>D x W = 60 x 30 mm</p> <p style="text-align: center;">BT TOY16 TOY127/TOY130</p>	<p style="text-align: center;">TOYOTA</p>  <p>D x W = 60 x 33 mm</p> <p style="text-align: center;">BT TOY17 TOY127/130</p>	<p style="text-align: center;">TOYOTA</p>  <p>D x W = 50 x 26.5 mm</p> <p style="text-align: center;">BT TOY18 BMW111-TOYOTA APPLICATION</p>
<p style="text-align: center;">TOYOTA</p>  <p>D x W = 62 x 28 mm</p> <p style="text-align: center;">BT TOY19 TOY177</p>	<p style="text-align: center;">TOYOTA</p>  <p>D x W = 63 x 27 mm</p> <p style="text-align: center;">BT TOY20 TOY177</p>	<p style="text-align: center;">TOYOTA</p>  <p>D x W = 83 x 35 mm</p> <p style="text-align: center;">BT TOY21 TOY129-31</p>
<p style="text-align: center;">TOYOTA</p>  <p>D x W = 62 x 35 mm</p> <p style="text-align: center;">BT TOY22 TOY129-31</p>	<p style="text-align: center;">TOYOTA</p>  <p>D x W = 60 x 30 mm</p> <p style="text-align: center;">BT TOY23 TOY094R</p>	<p style="text-align: center;">TOYOTA</p>  <p>D x W = 62 x 28 mm</p> <p style="text-align: center;">BT TOY24 TOY097/TOY102</p>
<p style="text-align: center;">TOYOTA</p>  <p>D x W = 58 x 29 mm</p> <p style="text-align: center;">BT TOY25 TOY177-3SGE</p>	<p style="text-align: center;">TOYOTA</p>  <p>D x W = 59 x 29 mm</p> <p style="text-align: center;">BT TOY26 TOY178</p>	<p style="text-align: center;">TOYOTA</p>  <p>D x W = 62 x 40 mm</p> <p style="text-align: center;">BT TOY27 TOY191-36</p>
<p style="text-align: center;">TOYOTA</p>  <p>D x W = 62 x 40 mm</p> <p style="text-align: center;">BT TOY28 TOY191-36</p>	<p style="text-align: center;">TOYOTA</p>  <p>D x W = 62 x 28 mm</p> <p style="text-align: center;">BT TOY29 TOY105</p>	<p style="text-align: center;">TOYOTA</p>  <p>D x W = 57 x 29 mm</p> <p style="text-align: center;">BT TOY30 TOY124/TOY128-26</p>

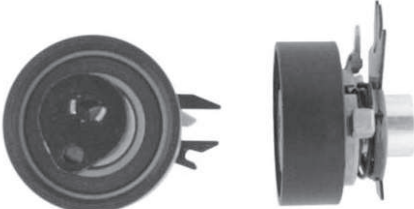
<p style="text-align: center;">TOYOTA</p>  <p>D x W = 54 x 27 mm</p> <p style="text-align: center;">BT TOY31 TOY124/TOY128-26</p>	<p style="text-align: center;">TOYOTA</p>  <p style="text-align: center;">BT TOY32 TOY097</p>	<p style="text-align: center;">TOYOTA</p>  <p>D x W = 62 x 36 mm</p> <p style="text-align: center;">BT TOY33 TOY209</p>
<p style="text-align: center;">TOYOTA</p>  <p>D x W = 66 x 38 mm</p> <p style="text-align: center;">BT TOY34 TOY209</p>	<p style="text-align: center;">VOLVO</p>  <p>D x W = 59 x 27 mm</p> <p style="text-align: center;">BT VOL01 VOL142</p>	<p style="text-align: center;">VOLVO</p>  <p>D x W = 53 x 27 mm</p> <p style="text-align: center;">BT VOL02 VOL142/VOL148</p>
<p style="text-align: center;">VOLVO</p>  <p>D x W = 53 x 27 mm</p> <p style="text-align: center;">BT VOL03 VOL148</p>	<p style="text-align: center;">VOLVO</p>  <p>D x W = 47 x 27 mm</p> <p style="text-align: center;">BT VOL04 VOL143</p>	<p style="text-align: center;">VOLVO</p>  <p>D x W = 47 x 26 mm</p> <p style="text-align: center;">BT VOL05 VOL143</p>
<p style="text-align: center;">VOLVO</p>  <p>D x W = 53 x 32 mm</p> <p style="text-align: center;">BT VOL06 VOL152</p>	<p style="text-align: center;">VOLVO</p>  <p>D x W = 53 x 32 mm</p> <p style="text-align: center;">BT VOL07 VOL152</p>	<p style="text-align: center;">VOLVO</p>  <p>D x W = 59 x 32 mm</p> <p style="text-align: center;">BT VOL08 VOL132</p>
<p style="text-align: center;">VOLVO</p>  <p>D x W = 53 x 32 mm</p> <p style="text-align: center;">BT VOL09 VOL132/VOL146</p>	<p style="text-align: center;">VOLVO</p>  <p>D x W = 59 x 32 mm</p> <p style="text-align: center;">BT VOL10 VOL146</p>	<p style="text-align: center;">VOLVO</p>  <p>D x W = 59.5 x 27 mm</p> <p style="text-align: center;">BT VOL11 VOL142</p>

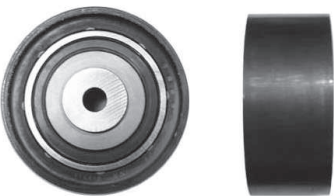
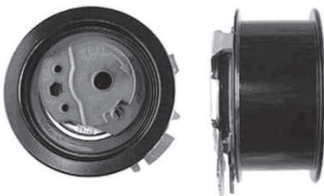
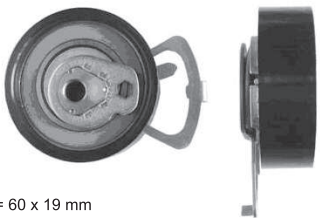
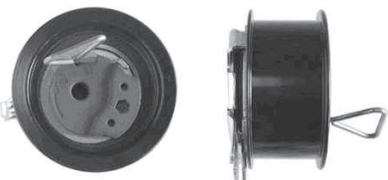
<p>VOLVO</p>  <p>D x W = 60 x 27 mm</p> <p>BT VOL12 VOL142</p>	<p>VOLVO</p>  <p>D x W = 53 x 32 mm</p> <p>BT VOL13 VOL152</p>	<p>VOLKSWAGEN/AUDI/PORSCHE</p>  <p>D x W = 72 x 21 mm <i>Includes mounting stud, nut and washer</i></p> <p>BT VW01 VW121/VW121R</p>
<p>VOLKSWAGEN</p>  <p>D x W = 73 x 26 mm</p> <p>BT VW02 VW147</p>	<p>VOLKSWAGEN</p>  <p>D x W = 73 x 26 mm</p> <p>BT VW03 VW135-25</p>	<p>VOLKSWAGEN/AUDI</p>  <p>D x W = 72 x 21 mm</p> <p>BT VW04 VW124</p>
<p>VOLKSWAGEN</p>  <p>D x W = 75 x 28 mm</p> <p>BT VW05 VW113/VW120/VW122/AUD119</p>	<p>VOLKSWAGEN</p>  <p>D x W = 71 x 28 mm</p> <p>BT VW06 AUD142</p>	<p>VOLKSWAGEN</p>  <p>D x W = 67 x 26 mm</p> <p>BT VW07 VW137-25</p>
<p>VOLKSWAGEN</p>  <p>D x W = 29 x 29 mm</p> <p>BT VW08 VW137-25</p>	<p>VOLKSWAGEN</p>  <p>D x W = 72 x 25 mm</p> <p>BT VW09 VW138</p>	<p>VOLKSWAGEN</p>  <p>D x W = 68 x 26 mm</p> <p>BT VW10 VW141-25P/VW141-25S</p>
<p>VOLKSWAGEN</p>  <p>D x W = 80 x 29 mm</p> <p>BT VW11 VW141-25P/VW141-25S</p>	<p>VOLKSWAGEN</p>  <p>D x W = 72 x 26 mm</p> <p>BT VW12 VW147/VW151</p>	<p>VOLKSWAGEN</p>  <p>D x W = 29 x 29 mm</p> <p>BT VW13 VW141-25P/VW141-25S</p>

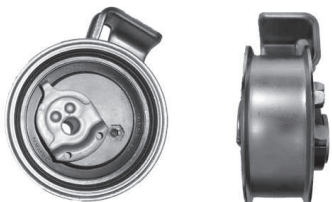
<p>VOLKSWAGEN</p>  <p>D x W = 66 x 24 mm</p> <p>BT VW14 VW081</p>	<p>VOLKSWAGEN</p>  <p>D x W = 63 x 24 mm</p> <p>BT VW15 VW081</p>	<p>VOLKSWAGEN</p>  <p>D x W = 74 x 27 mm</p> <p>BT VW16 VW122</p>
<p>VOLKSWAGEN</p>  <p>D x W = 60 x 25 mm</p> <p>BT VW17 VW130</p>	<p>VOLKSWAGEN</p>  <p>D x W = 56 x 22 mm</p> <p>BT VW18 VW130</p>	<p>VOLKSWAGEN</p>  <p>D x W = 29 x 29 mm</p> <p>BT VW19 VW130</p>
<p>VOLKSWAGEN</p>  <p>D x W = 62 x 22 mm</p> <p>8 mm Mounting Hole</p> <p>BT VW20 VW137-19</p>	<p>VOLKSWAGEN</p>  <p>D x W = 62 x 22 mm</p> <p>8.5 mm Mounting Hole</p> <p>BT VW21 VW135R-19</p>	<p>VOLKSWAGEN/SEAT</p>  <p>D x W = 40 x 36 mm</p> <p>BT VW22 VW141-30/AUD160-25/AUD160-30</p>
<p>VOLKSWAGEN/SEAT</p>  <p>D x W = 80 x 34 mm</p> <p>10 mm Mounting Hole</p> <p>BT VW23 VW141-30/AUD160-30</p>	<p>VOLKSWAGEN/SEAT</p>  <p>D x W = 68 x 31 mm</p> <p>BT VW24 VW120-30/VW141-30</p>	<p>VOLKSWAGEN</p>  <p>D x W = 60 x 19 mm</p> <p>BT VW25 VW058</p>
<p>VOLKSWAGEN</p>  <p>D x W = 67 x 31 mm</p> <p>BT VW26 VW120-30</p>	<p>VOLKSWAGEN</p>  <p>D x W = 40 x 36 mm</p> <p>BT VW27 VW120-30/VW141-30</p>	<p>VOLKSWAGEN</p>  <p>D x W = 72 x 30 mm</p> <p>BT VW28 AUD150-VW APPLICATION</p>

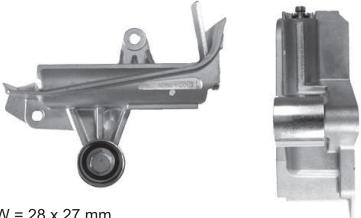
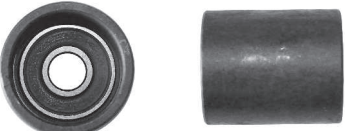
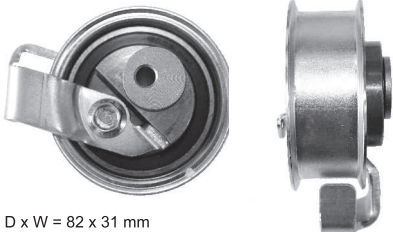
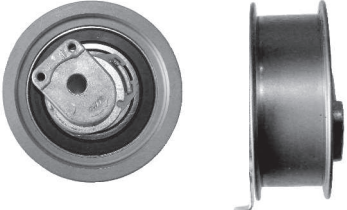
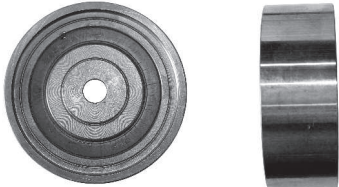
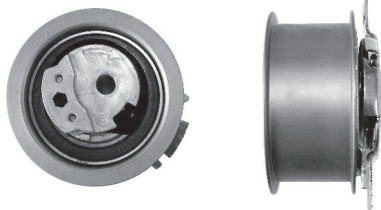
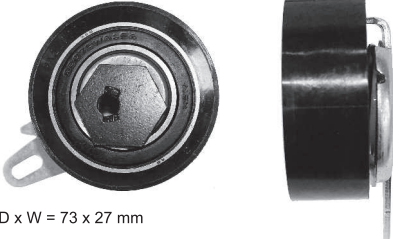
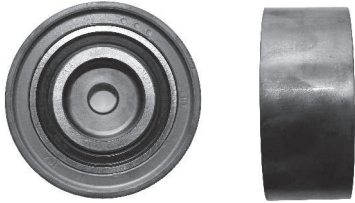
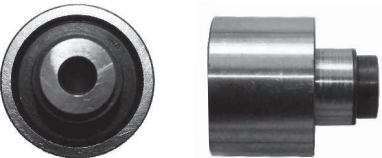
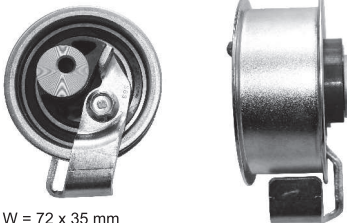
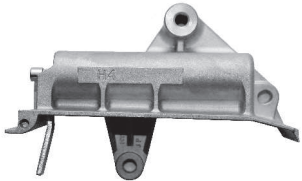
<p>VOLKSWAGEN</p>	<p>VOLKSWAGEN</p>	<p>VOLKSWAGEN</p>
 <p>D x W = 28 x 27 mm</p>	 <p>D x W = 29 x 34 mm</p>	 <p>D x W = 82 x 31 mm</p>
<p>BT VW29 AUD150-VW APPLICATION</p>	<p>BT VW30 VW120-30/VW141-30</p>	<p>BT VW31 AUD150-VW APPLICATION</p>
<p>VOLKSWAGEN</p>	<p>VOLKSWAGEN</p>	<p>VOLKSWAGEN</p>
 <p>D x W = 78 x 28 mm</p>	 <p>D x W = 80 x 29 mm</p>	 <p>D x W = 78 x 35 mm</p>
<p>BT VW32 AUD160-25</p>	<p>BT VW33 AUD160-25</p>	<p>BT VW34 AUD160-30</p>
<p>VOLKSWAGEN</p>	<p>VOLKSWAGEN</p>	<p>VOLKSWAGEN</p>
 <p>D x W = 73 x 27 mm</p>	 <p>D x W = 80 x 34.5 mm 12 mm hole</p>	 <p>D x W = 40 x 29 mm</p>
<p>BT VW35 VW141-26</p>	<p>BT VW36 VW141-30</p>	<p>BT VW37 AUD160-25</p>
<p>VOLKSWAGEN</p>	<p>VOLKSWAGEN</p>	
 <p>D x W = 72 x 35 mm</p>		
<p>BT VW38 VW120-30</p>	<p>BT VW39 VW120-30</p>	

TIMING BELT TENSIONER & IDLER WARRANTY POLICY LIMITED WARRANTY

We warrant to our direct customer only that we will replace any tensioner or idler sold by us which proves to be defective in material or workmanship during a 12 month period, from the date of purchase and installation on the first consumer's vehicle, or forty thousand (40 000) kilometres (whichever occurs first) or that proves not to be interchangeable with the tensioner or idler that it is intended to replace.

This warranty does not apply to any tensioner or idler that has been misused, incorrectly installed, subjected to extreme operating conditions, malfunctions due to foreign particles or tensioners or idlers used in a vehicle that has been altered or modified for usage other than it's intended purpose.

Any tensioner or idler returned for a warranty claim must be returned through our direct customer from whom it was purchased.

We reserve the right to examine and request for return all relevant parts to determine whether, or not, the tensioner or idler failed due to defects in material or workmanship.

This warranty is limited to the replacement of the tensioner or idler only and excludes all labour charges and incidental or consequential damage.



All Shimizu and Europart timing belt tensioners and idlers are manufactured with premium quality bearings with the specified radial clearances and internal tolerances, high-temperature lubricant and seals as per OEM specifications.



It is recommended that they are fitted in conjunction with **OEM quality GATES Full Service Distance timing belts** to ensure that the recommended service distance is achieved.



FULL SERVICE DISTANCE TIMING BELTS

Distributed by

AUTOBAX

South Africa

Division of
Humulani Marketing (Pty) Ltd
Reg. No. 2005/019581/07



CAPE TOWN BRANCH

22 Dawn Road
Montague Gardens
Phone: (021) 551 3489
Fax: (021) 551 6344
Email: admin@autobax.co.za

GAUTENG BRANCH

Unit 4, Lakeside
Cnr Kelly & Ackermann Streets, Jetpark
Phone: (011) 397 7409
Fax: (011) 397 2657
Email: adminjhb@autobax.co.za